



Missouri Smallflows Organization

# OUTHOUSE POST

A Quarterly Publication

Fall 2023

## IN THIS ISSUE

- What's Inside? .....Page 1.....
- Business Partnership Program Supporters .....Page 2.....
- Note from the Executive Director .....Page 3.....
- Meet Cecilia! .....Pages 5.....
- Septic Smart Week .....Page 8-9.....
- Realtor Workshop .....Page 10.....
- DHSS Update .....Page 12 -13.....
- Listing of MSO Classes .....Page 18.....
- Thank You Governor Parson .....Page 19.....
- 2024 MOWA Conference & Trade Show Registration .....Page 22.....
- Cardinals Game Fun! .....Page 26 .....

## IMPORTANT DHSS UPDATE

GOVERNOR **RECOGNIZES** MISSOURI  
 MIKE PARSON SMALL FLOWS



# REGISTER NOW!

Upcoming MSO  
**CLASSES AVAILABLE**

Online Classes Available For After Work Hours!





Missouri Smallflows Organization  
2733 E Battlefield #132  
Springfield, MO 65804

Phone: 417-631-4027

Email: [contact@mosmallflows.org](mailto:contact@mosmallflows.org)

## MSO OFFICERS

### Michael Bowers

*President*  
(417) 868-4147

### Sean Bauer

*Vice President*  
(573) 280-4130

### Jessi Wood

*Treasurer*  
(816) 966-8885

### Seth Coggin

*Secretary*  
(417) 291-5722

## MSO BOARD OF DIRECTORS

**Paul Ganey**  
(314) 973-0377

**Eric Folks**  
(573) 751-6095

**Kerry Clark**  
(660) 351-4696

**Nick Dykes**  
(816) 580-4100

**Larry LaFollette**  
(417) 736-4155

**Rick Wilcockson**  
(636) 358-7797

**Chris Nothstine**  
(660) 224-9043

## WELCOME TO OUR BUSINESS PARTNER PROGRAM SUPPORTERS

Thank you for supporting MSO's goals and our organization throughout the year.

### DIAMOND BUSINESS PARTNER PROGRAM

Webtrol  
SI Precast

### PLATINUM BUSINESS PARTNER PROGRAM

TG Rankin Company  
Infiltrator Water Technologies  
Stewart Concrete  
Missouri Water and Wastewater Products  
Innovative Pump Solutions

### GOLD BUSINESS PARTNER PROGRAM

Jet, Inc.  
Residential Sewage Treatment Company  
Allied Concrete Products  
Flo-Systems Inc.  
Ganey Engineering, LLC

If you are interested in being a part of our Business Partner Program check out the program on our website for more information.

## INTERESTED IN MAKING YOUR COMPANY A BUSINESS PARTNER?

We appreciate all of our BPP members. This program enables you and your company to purchase exhibit space, newsletter advertising and your MSO membership all in one stop.

As a BPP, your company logo and link to your website will be on the MSO website. You have a certain number of membership slots to whom you can assign anyone. Our newsletter reaches over 400 people quarterly and the list is growing. We send our newsletter via email and mail to some patrons.

We have varying levels of sponsorships based on your need. You should check out our BPP webpage ([www.mosmallflows.org](http://www.mosmallflows.org)) for the full details.

If you would like a copy of the brochure with prices and details, you may always contact Tammy Trantham at [contact@mosmallflows.org](mailto:contact@mosmallflows.org).

Let us help you get your company name out to our membership and more. Thank you for supporting Missouri Smallflows.

## A NOTE FROM THE EXECUTIVE DIRECTOR

MSO Members,

It's been a whirlwind summer for the organization on activities and classes. Thanks to our new AmeriCorps Assistant, Cecilia Kayser, MSO has the ability to create outreach programs for youth to learn about our industry. In this newsletter, you will see an article about a successful Career Day held at the Onsite Wastewater Training Center in Springfield. We had 30 high school students participate in various activities related to the industry. Big thank you to Jeff Julien, Stewart Concrete, and Michael Bowers, Greene County Resource Management, for teaching youth and donating to the center.

MSO had a first-ever member event at a Springfield Cardinals game on September 9. Thank you to each member that came. We had great seats while we enjoyed hot dogs and brats. We hope to do this again next year.

We are partnering with two other non-profit organizations near Springfield to put on a class for realtors to educate them about onsite wastewater treatment systems. See the information in the newsletter and feel free to pass along the registration information. We also plan to host another one of these events in December in the central part of the state. More information will come soon on this!

There is a bunch of information in this newsletter about becoming certified and renewing your certification. Lately, I have received many phone calls on the steps required to complete these tasks. Between DHSS and MSO, we do our best to answer your questions. However, many of your questions can be answered through looking at the DHSS website. Please read this article and see our tips to help you navigate these questions. In addition, DHSS has re-worked their website, so it is easier to navigate.

You will see some information about the 2024 MSO Conference and Trade Show in this newsletter. CEUs have been requested from DHSS but are in the process of being approved. I will post on the website when I receive this approval. However, REGISTRATION is OPEN! You can register early and save your spot. The Pre-Conference usually fills up so register early to save your seat! We'll be at the Holiday Inn Executive Center in Columbia on January 15 (Pre-Conference) through January 16-17 (Conference).

Thank you all for continuing to renew your membership throughout the year. We are working towards making this easier on our website but I appreciate your support for the organization.

Best regards,

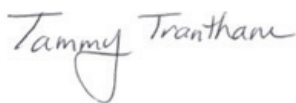

Tammy Trantham  
Executive Director



There when you need us most

# Count on us.



Pumps | Tanks & Basins | Pump Stations

Residential & Commercial Treatment

Controls | Drain Field Products

EZ-Pull

## Monitor Unattended Pump Stations



**NEW!**

Remote monitoring and control of pump stations can be done through real time notifications and alarms to your computer or cell phone. You can monitor:

- high water levels
- power or pump failures
- other custom set thresholds

Minimize on-site visits and repairs! Call us about our IQ2 remote monitoring.

**St. Louis** 314-631-9200 **West Plains** Christina: 417-256-1255 **Lake of the Ozarks** Zach: 573-374-6444

**Arkansas & SW MO** Raymon: 479-640-0052

# Meet MSO's Americorps Assistant! Cecilia Kayser



Cecilia, a recent graduate of Missouri State with a Master's degree in Environmental Geology, discovered her passion for outdoor education while working at Outdoor Adventures during her time at the university. Her enthusiasm for imparting knowledge about the outdoors was ignited during this period. Whether it's rock climbing, biking, or running, Cecilia is drawn to any outdoor activity. As an avid environmental geologist, she possesses a profound love for the natural world. Exploring the wonders both above and below the surface brings her immense joy. Among her greatest passions is sharing her knowledge and educating others about the fascinating world around us, particularly emphasizing the significance of rocks.



**AmeriCorps**



**Missouri  
Smallflows  
Organization**

# Wastewater Solutions

Treatment

Dispersal

Storage

Pumping

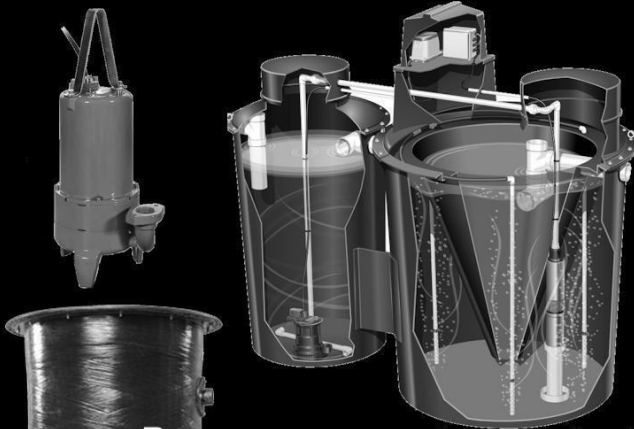

Pressure Sewer Systems

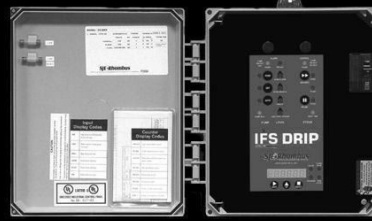

SJE RHOMBUS

Pump Controls



Effluent Pumps

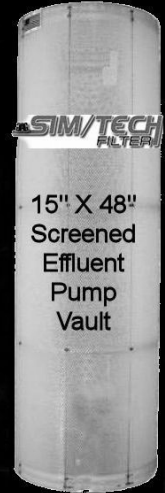

15" X 48" Screened Effluent Pump Vault



UV Disinfection



SJE Rhombus Solar Powered Alarm

Polylok D-Box

Polylok PL122 Effluent Filter

NSF

Salcor 3G UV

Drip Irrigation



STEP vaults

Snyder Septic Tanks Poly Nexgen D2



## TG Rankin Co

233 Chesterfield Ind Blvd  
Chesterfield, Mo 63005  
636-532-4555  
636-532-4716 fax

1801 Jasper St  
N Kansas City, MO 64116  
816-421-4646  
fax 816-421-6120

[www.tgrankin.com](http://www.tgrankin.com)

Residential

Commercial

Municipal

# INNOVATIVE PUMP SOLUTIONS

PHONE (417) 343-2211 FAX (417) 212-5346

ROGERSVILLE, MO

PROUDLY SERVING MISSOURI, ARKANSAS & ILLINOIS

PUMPS -- BASINS -- CONTROLS -- VFD'S  
SWITCHES -- CONSTANT PRESSURE SYSTEMS  
PHASE CONVERSION -- VOLTAGE DOUBLING

ORDERS IN BY 1:30 SHIP SAME DAY ON STOCKED ITEMS



**Franklin Electric**





# Missouri Smallflows Organization

## SEPTIC SMART WEEK

### ***Exploring Career Paths:*** High School Students Get Hands on Experience

By Cecilia Kayser

MSO put on a Career Day to showcase alternative career paths that may or may not require a college degree in the onsite wastewater industry. Students participated in unique activities to broaden horizons and showcase alternative career paths that don't require a college degree, our local high school recently organized a unique activity that exposed students to the world of pipe systems, sewage, and septic installation. Through a series of hands-on activities, students gained valuable insights and developed new skills while discovering the diverse and fulfilling opportunities in these fields.



### **1. Building a Pipe System:**

Students were introduced to the fundamentals of pipe systems, learning how they function in various settings.

They had the chance to design and construct a basic pipe system, under the guidance of experienced professionals. Impact: This activity not only allowed students to get their hands dirty but also fostered teamwork and problem-solving skills. They gained a deeper appreciation for the complexity of pipe systems, and many discovered a newfound interest in this field.





## 2. Soil Evaluation Lab:

In this lab, students learned how to assess soil properties and suitability for various construction purposes. They assessed the soils by looking at texture, color, and structure.

Impact: Understanding soil properties is vital for successful pipe systems, sewage, and septic installation. This activity exposed students to the scientific aspects of these careers, highlighting the significance of soil analysis in ensuring infrastructure longevity and functionality.



## 3. Land Contours and Trench Technologies

Students were taught how to use a clinometer, an essential tool in professions related to pipe systems and construction. Students were given hands-on experience in measuring slopes with a clinometer and laser elevation tools. The different types of conventional treatment methods were discussed from the trench technologies available at the training center.

Impact: By mastering this precise instrument, students realized the importance of accuracy in construction work. They also grasped the connection between elevation and effective pipe system installation, opening their eyes to potential careers where this skill is crucial.

## The Impact on These Kids:

Many students previously unaware of these non-college career paths now have a clearer picture of the opportunities available. The hands-on nature of these activities made learning engaging and memorable, and students appreciated the chance to apply theoretical knowledge in real-world scenarios.

Skill Development: Students developed valuable skills such as teamwork, problem-solving, and technical proficiency.

Career Awareness: By interacting with industry professionals, students gained insights into the diverse job roles within pipe systems, sewage, and septic installation without having to obtain a college degree.

# Realtor Workshop



**Missouri  
Smallflows  
Organization**

Greene County Onsite Wastewater Treatment System Workshop for Realtors  
Event Hosts: James River Basin Partnership, Missouri Smallflows Organization, and The Watershed

Place: Praise Assembly, 3535 N Glenstone Ave., Springfield, MO

Date: Thursday, November 9, 2023

Time: 8:00 AM – 1:00 PM

Admission: \$30 for lunch and continuing education credits

Register at: <https://www.jamesriverbasin.com/owts-workshop>

### Agenda:

Course: Onsite Wastewater Treatment System (OWTS) Inspection/Evaluation Procedure  
for Real Estate Professionals

Duration: 2.75 Hours in the Classroom + 1 Hour Field Tour = 3.75 CEC

### Agenda:

8:00 AM – 8:30 AM	Breakfast provided & Registration Check-in
8:30 AM – 9:30 AM	OWTS Assessments: Let's Begin
9:30 AM – 10:15 AM	OWTS Assessments: Continued
10:15 AM – 10:30 AM	Break
10:30 AM – 11:30 AM	OWTS Assessments: The Finish Line
11:30 AM – 11:45 AM	Travel to Training Center
11:45 AM – 12:45 PM	Tour of Onsite Wastewater Training Center
12:45 PM	Evaluations & Certificates



# GANEY

---

## ENGINEERING

*Protecting Today's Ground Water for Tomorrow*

P.O. Box 308, Arnold, MO 63010

314-973-0377

ganeyengineering@yahoo.com

- septic system design
- sewer system design
- septic system evaluations
- onsite wastewater consulting
- Aeration Unit Supplier
- storm water consulting

# Geoflow

Subsurface Drip



Wasteflow Dripline



BioDisc Filters



Flow Meters



Panels



Valves



Air Vents

800.828.3388

■ [geoflow.com](http://geoflow.com)

## Important Updates from DHSS

Authors: Breanna Werdehausen, Missouri DHSS, and Tammy Trantham, MSO

The Onsite Wastewater Program has undergone some changes over the past 6 months and we want to make sure you are aware of a few items! Please note these important resources when you have questions on registration/licensure, CEUs or permitting.



### Installer Registration

If you are another person for your company is looking to become a registered installer, they will need to enroll in the in-person installer class and take the exam. These classes fill up approximately 2 months in advance so the earlier you can sign up the better. Paying online and returning your registration forms via email is the fastest way to enroll. Visit [health.mo.gov/onsite](http://health.mo.gov/onsite) and click on "Become Registered/Licensed" for available course dates, registration forms and link to pay online. Be sure to return your registration form via email once you have paid or you will not be registered. The Program will email you a confirmation once you are registered for a class.

When you are at the end of your 3-year period for your registration and are ready to renew, there are a few steps to do this:

1. Renewal notices are sent by mail to your last known address 60 days prior to expiration. If you do not have an accurate address at DHSS, you will not receive the form. If you are within 45 days of expiration and have not received your renewal form OR if your contact information has recently changed; contact the Program at [OWTScourses@health.mo.gov](mailto:OWTScourses@health.mo.gov).
2. Renewal fees can be paid online but the renewal form and CEU certificates must still be sent to the Program. The fastest method is to send via email to [OWTScourses@health.mo.gov](mailto:OWTScourses@health.mo.gov).
3. It takes up to 30 days for your renewal to be processed. That means if you submit your paperwork, on the last day of your certification, you may not get a recertification letter/card until a month later.
4. CEU Report: You are asked to submit your CEU certificates with your renewal. If you take MSO Seminar classes, these are automatically sent in. If you take MSO Online Classes or other classes outside of MSO, you must submit the completion certificates to DHSS. Either by email ([OWTScourses@health.mo.gov](mailto:OWTScourses@health.mo.gov)) or by mail with your renewal form.
5. NOTE: ID Cards are sent out via email for electronic cards. They are no longer sent out in physical card format. Contact DHSS for questions on this: [OWTScourses@health.mo.gov](mailto:OWTScourses@health.mo.gov).

## CEU Information

It is now the responsibility of the professional to track their own CEUs. DHSS is unable to provide reports or updates on the status of your CEUs throughout your certification period. DHSS did create an Excel spreadsheet for you to track your own CEUs. This does require Excel to run.



1. DHSS Information on CEUs: [health.mo.gov/onsite](http://health.mo.gov/onsite) click on "CEU Information"
2. Approved CEU course schedule from DHSS: <https://health.mo.gov/living/environment/onsite/pdf/CEUcoursereport.pdf>
3. MSO Seminar Course Schedule: <http://www.mosmallflows.org/seminar-classes.html>
4. MSO Online Classes: <http://www.mosmallflows.org/online-classes.html>
5. Non-Pre-approved CEUs: You must fill out the form and submit this to DHSS for consideration of CEUs. <https://health.mo.gov/living/environment/onsite/pdf/CEUApplication.pdf>

## Requirements for CEUs

<b>CEU REQUIREMENT BY LICENSE TYPE</b>		
<b>REMINDER: CEUs must be completed during the renewal period and every renewal period is 3 years. To determine if your CEUs count toward your license, determine if the course was completed within 3 years of your current expiration date.</b>		
	<b>General</b>	<b>Select</b>
<b>Basic Installer:</b>		
1st renewal (first three years after registration)	20	8
Subsequent renewals (every three year period thereafter)	8	0
<b>Advanced Installer:</b>		
<i>Advanced installers do not need to track basic CEUs</i>		
1st renewal (first three years after registration)	20	8
Subsequent renewals (every three year period thereafter)	12	8
<b>Inspector:</b>		
1st renewal (first three years after licensure)	20	8
Subsequent renewals (every three year period thereafter)	12	8
<b>Onsite Soil Evaluator:</b>		
1st renewal (first three years after registration)	20	8
Subsequent renewals (every three year period thereafter)	12	8
<b>Percolation Tester:</b>		
1st renewal (first three years after registration)	20	8
Subsequent renewals (every three year period thereafter)	8	0

## Permitting

A construction permit is required before installing or repairing most onsite wastewater treatment systems (OWTS). Some single-family residential lots may be exempt from permitting. The first step of the permitting process is to determine the agency that has permitting authority where the work is being done.



DHSS OWTS permitting falls under one of three authority types: DHSS Onsite Program, Local Authority (contract), or Local Authority via Ordinance. The application process varies by permitting authority. Work should not begin until a permit has been issued or an exemption to permitting has been confirmed by the appropriate permitting authority.

You can look up your permitting authority for the county you work in here: [health.mo.gov/onsite](http://health.mo.gov/onsite) click on "Apply for a Permit"

# RENEW YOUR MSO MEMBERSHIP!

Call or email the MSO office to check your membership status



**Membership only costs \$140 each year!**

## Thank you for supporting MSO!



### STEWART Concrete Products

*Proudly providing Missouri and the surrounding region with quality wastewater products*



**INFILTRATOR®**  
water technologies

Lincoln, MO  
(800) 743-0304  
Webb City, MO  
(888) 673-3321

**norweco®**

Engineering the future of water  
and wastewater treatment

Halfway, MO  
(800) 798-0183

**ZOELLER®**  
PUMP COMPANY

Spokane, MO  
(877) 777-4302  
Nevada, MO  
(800) 743-0305

# ORENCO ONSITE PRODUCTS

**Built** to work together. **Built** for the job. **Built** to last.



## Lids, Risers & More

- Lids that don't warp or collapse
- Risers that don't deform
- Riser safety grates
- Riser/tank adapters
- Adhesives and dispensing guns
- All parts watertight
- Standard and custom sizes

## Filters & Pump Vaults

- Filters that go longer between cleanings
- Pumps that last for decades
- Pump vaults for any kind of tanks
- Complete pumping systems

## Controls

- Complete panel kits with floats
- Touch-safe controls
- Name-brand parts
- Resettable breakers
- Long-lasting contractors, millions of cycles
- UL, UL-C, CE listings; UL Type 4 rating



Missouri Water & Wastewater Products, Inc.  
515 Old South 5, Camdenton, MO 65020  
573-346-9991 • sales@mwwp.biz

Seth A. Coggin, P.E. • 417-291-5722  
sethcoggin@mwwp.biz



814 Airway Ave., Sutherlin, OR 97479, USA  
1-800-348-9843 • 1-541-459-4449 • www.orencosystems.com



Missouri  
Smallflows  
Organization

## 2024 MSO Annual Conference & Trade Show

Holiday Inn Executive Center, Columbia, Missouri

**Monday, January 15, 2024**

### Pre-Conference Session

**Registration opens at 7:00 AM and class is from 8:00 AM to 5:00 PM**

Lunch Provided. Registration required for whole day.

### AM Session: Sand-based Treatment Systems in Missouri

Kevin Moreau, Infiltrator Water Technologies and Drew Nickoli, Eljen Corporation

### PM Session: Septic Tank Installation Tips and Proper Inspection of Tanks

Jeff Julien, Stewart Concrete; Sean Bauer, SI Precast; Curtis Cluckey, IWT; Rick Wilcockson

DHSS General CEUs: Pending Approval

**Tuesday, January 16, 2024**

**CEUs pending.**

Start	Finish	Session or Event		
7:30 AM	5:00 PM	Registration open		
<b>7:30 AM</b>	<b>9:00 AM</b>	<b>Exhibit Hall opens at 7:30 AM with HOT BREAKFAST!</b>		
9:00 AM	9:30 AM	Welcome by MSO President, Michael Bowers; Updates from Missouri DNR and DHSS		
9:30 AM	10:30 AM	Keynote Address 1: Closing America's Access Gap Community Initiative, Mark Gross		
10:30 AM	11:30 AM	Keynote Address 2: System Failure Identification, Lee Shamblin		
11:30 AM	1:00 PM	<b>Lunch in Exhibit Hall. Roe-D-Hoe Trials start.</b>		
12:15 PM	1:00 PM	<b>General Membership Meeting in Windsor III</b>		
Tracks		Installer Track	Inspector/Soils Track	General Topic
Room		Windsor I	Windsor II	Windsor III
1:00 PM	2:00 PM	Choosing the Right System for the Site Daniel Drury	Interpreting a Soils Evaluation for OWTS Installation options  Rachelle Kuster	What's my role?  Rick Wilcockson
2:00 PM	2:30 PM	<b>Break in Exhibit Hall. Roe-D-Hoe Trials</b>		



<b>MSO Annual Convention &amp; Trade Show</b>					
<b>Tuesday, January 16, 2024</b>					
CEUs pending.					
<b>Tracks</b>		<b>Installer</b>	<b>Inspector/Soils</b>	<b>General Topic</b>	
<b>Room</b>		<b>Windsor I</b>	<b>Windsor II</b>	<b>Windsor III</b>	
2:30 PM	3:30 PM	Pumps & Controls for Wastewater Treatment Mike Stephens, SCS Systems	A Day in the life of a Septic Inspector Brendan Murphy	Understanding the Variance Process Eric Folks	
3:30 PM	4:00 PM	<b>Break in Exhibit Hall. Roe-D-Hoe Trials!</b>			
4:00 PM	5:00 PM	Tank Buoyancy & Anti-Flotation Measures Kevin Moreau	What is a DHSS Real Estate Inspection? Breanna Werdehausen	Creating Systems: The Key to Limiting Liability, Increased Profits, Lower Stress and Enjoying your time off! Chris Orf	
5:00 PM	7:00 PM	<b>Membership Appreciation &amp; Roe-D-Hoe in Exhibit Hall. Come for Door Prizes!</b>			
8:00 PM	10:30 PM	<b>Evening Social at Sports Zone</b>			
<b>Wednesday, January 17, 2024</b>					
CEUs pending.					
7:30 AM	8:30 AM	<b>Hot Breakfast in Exhibit Hall!</b>			
<b>Tracks</b>		<b>Installer</b>	<b>Inspector/Soils</b>	<b>General Topic</b>	
<b>Room</b>		<b>Windsor I</b>	<b>Windsor II</b>	<b>Windsor III</b>	
8:00 AM	9:00 AM	Troubleshooting Wastewater Systems - Mike Stephens, SCS Systems	General Design for Presby Systems in Missouri Chris Nothstine	Ditchin' Ain't Easy: Making Sure Trenches are Safe Mark Woodward, MEM	
9:00 AM	9:30 AM	<b>Break in Exhibit Hall</b>			
9:30 AM	10:30 AM	Pump Selection Mark Gross	Inspections - Tools of the Trade Douglas Wade Hurrelbrink	Onsite Wastewater Safety Rick Kirkpatrick	
10:30 AM	10:45 AM	<b>Break in Parliament 1 &amp; 2</b>			
10:45 AM	11:45 AM	Consequences of Corner Cutting - What's right is right, What's wrong is wrong Nick Dykes	The History of Soil Science Michael Bowers	Focus 4 Plus 1: The 5 Most Important Excavation Jobsite Safety Concerns Mark Woodward, MEM	
11:45 AM		Conference Adjourns			

# LISTING OF MSO CLASSES

**PLEASE REGISTER AT LEAST TWO WEEKS PRIOR TO THE CLASS!**

Call our office to register at 417-631-4027

Or find the Registration Form on our website: [www.mosmallflows.org](http://www.mosmallflows.org)

<p><b>Inspecting Tanks, Lagoons &amp; LPP</b>  <b>Location: Imperial, Ganey Engineering</b>  <b>Date: October 17, 2023</b>            Full day class: 8:30 AM - 4:00 PM            DHSS General CEUs: 5.0            Select CEUs: Basic: 0, Advanced: 0, Inspector: 5, OSE: 0, Perc Tester: 0</p> <p>Member price: \$130            Non-member price: \$200</p>	<p><b>Trickling through Media Filters</b>  <b>Location: Imperial, Ganey Engineering</b>  <b>Date: October 18, 2023</b>            Full day class: 8:30 AM - 4:00 PM            CEUs: General CEUs: 6            Select: Basic: 0, Advanced: 6.0, Inspectors: 4.0, Onsite Soil Evaluators: 0, and Percolation Testers: 0</p> <p>Member price: \$130            Non-member price: \$200</p>
<p><b>Basic Soils &amp; How to Read a Soils Report</b>  <b>Location: Springfield, SI Precast</b>  <b>Date: November 1, 2023</b>            Half-day class: 8:30 AM - 2:00 PM            DHSS General CEU: 5            Select: Basic: 5, Advanced: 5, Inspector: 0, OSE: 5, Perc Tester: 2</p> <p>Member price: \$130            Non-member price: \$200</p>	<p><b>Wastewater Pathogens</b>  <b>Location: Springfield, SI Precast</b>  <b>Date: November 2, 2023</b>            Half-day class: 8:30 AM - 1:00 PM            DHSS General CEU: 4            Select: Basic: 1, Advanced: 1, Inspector: 1, OSE: 0, Perc Tester: 0            DNR CEUs: 4.0 Wastewater (Green Vouchers accepted)</p> <p>Member price: \$130            Non-member price: \$200</p>
<p><b>Aerated Treatment Units</b>  <b>Location: Jefferson City, Cole County Health Department</b>  <b>Date: November 9, 2023</b>            Full day class: 8:30 AM - 4:00 PM            General CEUs: 6            Basic Installers: 3.5, Advanced Installers: 6, Inspectors and Evaluators: 3.5, Onsite Soil Evaluators: 1.0, and Percolation Testers: 1.0</p> <p>Member price: \$130            Non-member price: \$200</p>	<p><b>Drip Irrigation</b>  <b>Location: Jefferson City, Cole County Health Department</b>  <b>Date: November 10, 2023</b>            Full day class: 8:30 AM - 4:00 PM            General CEUs = 6            Basic Installers: 3.5, Advanced Installers: 6, Inspectors and Evaluators: 6, OSE: 3.5, and Percolation Testers: 0</p> <p>Member price: \$130            Non-member price: \$200</p>

**More classes are being scheduled.**

See our online classes available on our website: [www.mosmallflows.org](http://www.mosmallflows.org)

Seminar refund policy available online

## Thank You to Governor Parson!

Governor Mike Parson recognized our industry throughout September. We appreciate the Governor taking the time to see that our industry has an integral role with the Missouri economy.

### September 10-16 – Water and Wastewater Treatment Professionals Week

Governor Mike Parson has signed a proclamation declaring Sept. 10-16, 2023, as Water and Wastewater Treatment Professionals Week in Missouri. The Governor’s proclamation recognizes the vital work that water and wastewater treatment professionals do to keep Missourians healthy and our communities strong.

The proclamation highlights the important contributions made by water and wastewater professionals to protect the public health of Missouri citizens, and improve water quality for the state’s streams, rivers and lakes. Water and Wastewater Treatment Professionals Week offers the perfect opportunity to recognize the vital role these professionals play in all of our lives.



### September 18 – 22 – Septic Smart Week

Governor Mike Parson signed the proclamation for Septic Smart Week honoring the professional of Missouri Smallflows Organization. You can see the proclamation on the Governor’s website: <https://governor.mo.gov/proclamations/septic-smart-week>

# We have something new to show the Show-Me State!

See us at this year's MEGA-Conference, co-hosted by MSO & NOWRA!  
October 30 thru November 2 in Springfield, MO.  
(If you can't wait, call today!)



- Simple Installs
- Simple Treatment & Disposal • Simple maintenance • Flexible design options
- Perfect for small and complicated sites as well as commercial operations

Ask us about  
Training Seminars  
in your area!

**eljen**  
CORPORATION

Innovative Onsite Products and Solutions Since 1970

800-444-2359

[www.eljen.com](http://www.eljen.com)





**Manufacturers of  
 STEPS-SEPTIC TANKS  
 PARKING CURBS-SPLASH BLOCKS-GREASE INTERCEPTORS  
 AIR CONDITIONER BASES-PRECAST CONSTRUCTION ITEMS  
 CONCRETE FENCE**



## Does your customer have a grinder pump problem?

Need a partner for servicing or replacing grinder pumps when your customer calls? Call Flo-Systems to help you out. Let us Help You service your customers.

If you need a helping hand when a customer calls about their grinder pump, let us go make the service call for you. We can be an extension of your service crew. Let Flo-Systems provide your client with with an Upgrade from E/One, We can perform the work, and do the billing for you. Call to discuss the details

Contact your local sales representative:  
 Flo-Systems Process Equipment, Inc.  
 905 Cherry Ln • Troy, IL 62294  
 618-667-7890 • [www.flosystems.com](http://www.flosystems.com)  
 Dan Hufker 618-979-0884





**2024 MSO Conference Registration**  
**January 15-17, 2024**  
**Holiday Inn Executive Center, Columbia**

**MSO Membership**

You must be a **current member at the date of the conference** to take advantage of membership pricing. Check your membership status by calling the MSO office or emailing our office.

\_\_\_\_\_ Individual Annual Dues (\$140)

If you would like a Company Membership for 4 or more employees call our office

**2024 Conference Registration**

**Pre-Conference, January 15: Sand-based Treatment Systems in Missouri and Septic Tank Installation, Tips and Proper Inspection of Tanks**

\_\_\_\_\_ \$165 Member    \_\_\_\_\_ \$305 Non-member (includes one-year membership)

**Conference, January 16-17**

\_\_\_\_\_ \$165 Member    \_\_\_\_\_ \$305 Non-member (includes one-year membership)

Register after December 30, 2023, add \$25 late fee: \_\_\_\_\_

Guest/Spouse Fee \$100: \_\_\_\_\_ Name: \_\_\_\_\_

This fee only covers events on January 16-17. **This does not include the Pre-Conference on January 15.**

\_\_\_\_\_ Yes! I would like to donate \$5 or \$\_\_\_\_\_ to the Daryel Brock Memorial Scholarship Fund.

**Total of Payment:** \_\_\_\_\_

**Registration Information**

Member Name: \_\_\_\_\_

Name as it would appear on name badge: \_\_\_\_\_

Company Name: \_\_\_\_\_

Mailing Address: \_\_\_\_\_ City: \_\_\_\_\_

State: \_\_\_\_\_ ZIP: \_\_\_\_\_ Phone: \_\_\_\_\_

Email Address: \_\_\_\_\_ Cell Phone: \_\_\_\_\_

License Number: Basic Installer: \_\_\_\_\_ Advanced Installer: \_\_\_\_\_ Inspector: \_\_\_\_\_

OSE: \_\_\_\_\_ Perc Tester: \_\_\_\_\_

Send Form and Payment to:  
**Missouri Smallflows Organization**  
**2733 E. Battlefield #132**  
**Springfield, MO 65804**  
 Phone: 417-631-4027  
 Email: contact@mosmallflows.org

\_\_\_\_ Check here if card billing address is same as mailing.  
 We do not accept American Express.  
 Card #: \_\_\_\_\_  
 Exp: \_\_\_\_/\_\_\_\_ CVV: \_\_\_\_\_  
 Name on Card: \_\_\_\_\_  
 Card Billing Street Address: \_\_\_\_\_  
 Card Billing ZIP Code: \_\_\_\_\_



## Flagg-Air® 340HT Series

The Flagg-Air® shaft-style septic aerators are compatible replacements for OEM aerators in Jet® and Norweco Singlair®\* septic systems. Powder-coated steel brackets fit either the 10-inch Jet® or the 12-inch Norweco Singlair® tank openings.

- Proven performance in OEM tanks
- High-torque, continuous duty motor
- Made in the USA
- 2-Year limited warranty
- Trusted by professionals for over 30 years!

**ORDER TODAY!**

 **FREE SHIPPING** on orders over \$30

Special contractor pricing available!

(800) 778-1540 | [www.septicTankParts.com](http://www.septicTankParts.com)  
7059 Highway 47 Union, MO 63084

Flagg-Air® 340HT-J    Flagg-Air® 340HT-N

12-inch                      14-inch



**FA 340HT-N**   
Alternative for all  
Norweco® models

**FA 340HT-J**   
Alternative for all  
Jet® models



\*Norweco Singlair® is a registered trademark of Norwalk Wastewater Equipment Company, Inc. Jet® is a registered trademark of Jet, Inc. All original manufacturer's names, drawings and part numbers are used for identification purposes only and we are in no way implying that any of our products are original equipment parts, or are affiliated with, or endorsed or approved by the original manufacturers.

**Visit [SepticTankParts.com](http://SepticTankParts.com) for our entire line of septic pumps, aerators, rebuild kits, and more!**



**WHIRLWIND™**  
Linear Air Pumps



**WHIRLWIND™**  
Regenerative Blowers



**MAX FILTER SOCKS**  
(30-PK)



**MAXAIR500™**  
Submersible Aerator



# Residential

Sewage Treatment Company

12800 2nd Street

PO Box 248

Grandview, MO 64030-0248

Phone: 816-966-8885

Fax: 816-966-8778

Email: [info@residentialsewage.com](mailto:info@residentialsewage.com)

Website: [www.residentialsewage.com](http://www.residentialsewage.com)



*We specialize in sales, design, and service of alternative onsite wastewater products.*

*Distributing quality products from these manufacturers and more!*

*Norweco, Inc.*

*Allied Concrete Products*

*Infiltrator Water Technologies*

*Liberty Pumps*

*Geoflow, Inc.*

*SJE Rhombus*

*GAG Sim-Tech*

*K-Rain*

*Call our office today for a quote!*

## 816-966-8885

Like us on Facebook! 

## Your alternative wastewater specialist!



### MODEL 952

- UL listed as a NEMA 6p enclosure (watertight submergence test)
- Install directly in ground or in pump tank on effluent line
- Complete disinfection without the use of chemicals
- Hermetically sealed electrical components
- High capacity disinfective reservoir
- Kapton seals improve serviceability
- Rated treatment of 10 gallons/min

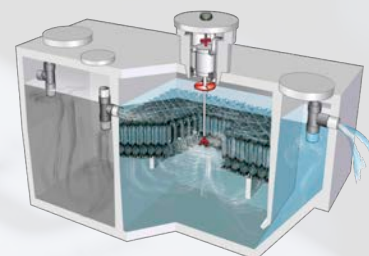
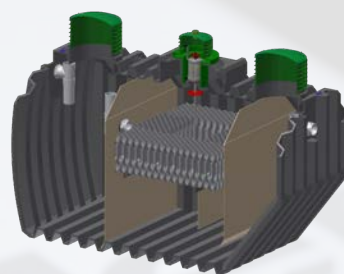

### RESIDENTIAL & COMMERCIAL TREATMENT PLANTS

- Concrete and rugged polyethylene material
- 500-1500 GPD Residential Systems
- 1500-300,000 GPD Commercial Systems
- Up to 800 GPD in plastic design
- A single moving part
- Innovative design for easy system servicing
- No filters to clog
- Lifetime exchange program

### ACCU-TAB WASTEWATER TABLETS

- U.S. made, recognized global brand with no imported ingredients
- Chlorine tablet with beveled edges to minimize wicking
- Consistent chlorine strength for reliable dosing control
- No measuring, mixing, or spilling of chemicals common with granular and liquid chlorine
- Stearate free formula with balanced pH



[www.jetincorp.com](http://www.jetincorp.com)  
440.461.2006



Wastewater Treatment Solutions  
Founded on Innovation. Anchored by Service.®





Recognized as the Leader  
in Precast Concrete Tanks  
& Specialty Products

Over  
**50+ Years**  
EXPERIENCE



**Residential & Commercial  
Waste Water Treatment Specialist**

Design, Build & Implement  
12,000 GPD to 96,000 GPD

Tony@precasttanks.com | 314-267-5375



Aerobic Septic Systems  
Class 1 Aeration 500 GPD to 1000 GPD

www.precasttanks.com



Install A Hoot Don't Pollute

**HOOT SYSTEMS, LLC.**

www.hootsystems.com

Call toll-free

**888.878.HOOT**

**LA- Hoot**

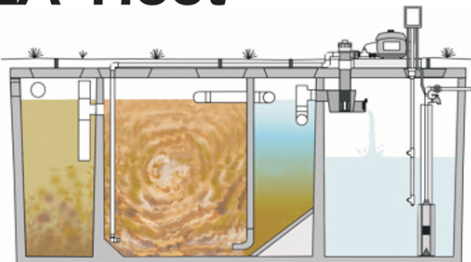

**Hoot Systems Offers:**

- 4 Models of NSF Standard 40 Systems
- 2 Models of NSF Standard 245 Systems
- Integrated Drip Packages

**Commercial & HS Treatment Systems for  
C-Stores, Restaurants, RV Parks, Schools,  
Churches and Shopping Centers**

Hoot Systems Local Dealer

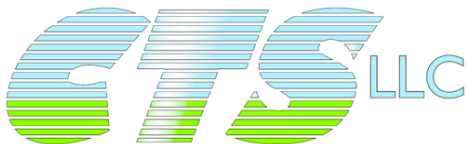

314-267-5375

**Please contact your Local Dealer -  
Tony Champion or the Hoot Corporate  
Office for more details!**



### Cardinals Game was fun for MSO Members!

MSO had a member event on September 9 at the Springfield Cardinals Stadium. Over 20 members attended and enjoyed the Cardinals winning the game by many runs!

Our tickets included ballpark food.  
The after-game fireworks were spectacular too!  
We thank the members for attending!  
We hope to do this again next year!

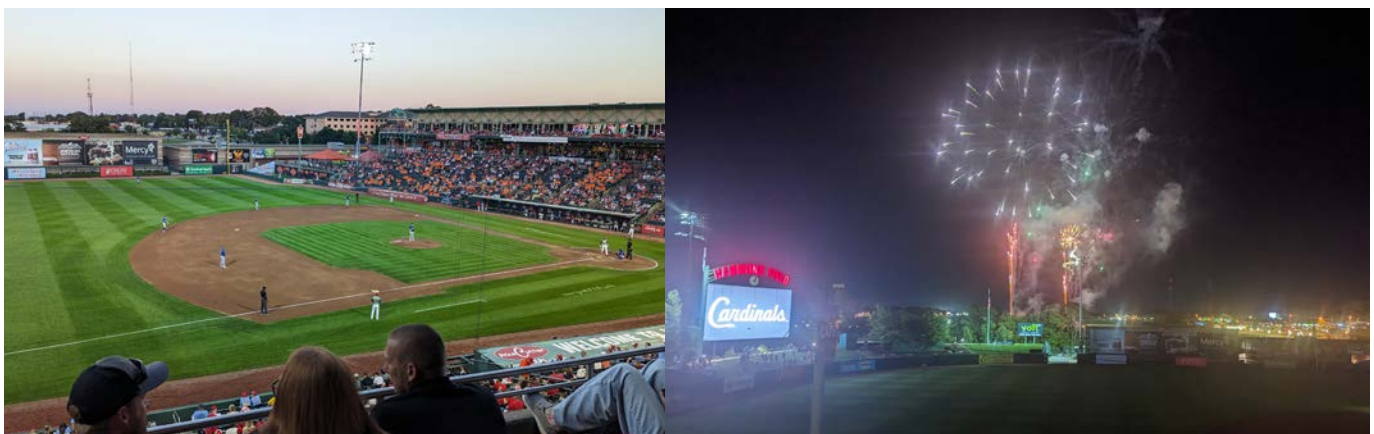



**INFILTRATOR**  
water technologies

# Engineered For Performance



## ADVANCED **ENVIRO**SEPTIC™

*Passive Onsite Wastewater Treatment Systems*

### **Combined Treatment and Dispersal**

- Treats and disperses wastewater in the same footprint
- Flexible configurations for sloped or curved sites
- Testing in accordance with NSF/ANSI 40 for treating domestic strength wastewater to Class I levels
- No electricity, replacement media or additional maintenance required



## Residential Advanced Wastewater Treatment Systems

Innovative approach to onsite wastewater disposal where nitrogen reduction is required.

- Nitrogen reduction greater than 50%
- The fixed film process suitable for continuous or intermittent use
- Industry proven solution with both NSF/ANSI 40 and 245 certifications
- Easy to maintain – no mechanical parts



Certified to  
NSF/ANSI Standards 40 & 245



**CALL FOR INFORMATION AND A DISTRIBUTOR NEAR YOU!**

Curtis Cluckey • (816)769-0087 • [ccluckey@infiltratorwater.com](mailto:ccluckey@infiltratorwater.com)  
Rick Kirkpatrick • (860) 575-8020 • [rkirkpatrick@infiltratorwater.com](mailto:rkirkpatrick@infiltratorwater.com)



**Missouri  
Smallflows  
Organization**

2733 E Battlefield #132  
Springfield, MO 65804

PRSR STD  
US POSTAGE  
PAID  
SPRINGFIELD,  
MO  
PERMIT #777



**YOUR TOTAL WASTEWATER SOLUTION**  
**888-262-7383**

**Residential**

Septic tanks  
Aerobic Treatment  
Drip Irrigation Packages  
Pumps and Controls  
Lids & Risers  
Infiltrator Chambers



**Commercial**

Treatment up to 100,000 gpd  
Custom Cast STEP Projects  
Sand Filter Components  
Grease Interceptors  
Commercial Size Castings  
Call Sean @ 573-280-4130

<b>Grandview, MO</b>	<b>St James, MO</b>	<b>Springfield, MO</b>	<b>Mtn Grove, MO</b>	<b>Jackson , MO</b>	<b>Versailles, MO</b>	<b>Moberly, MO</b>	<b>St Joe, MO</b>
816-966-9000 11919 Cartwright	573-265-7028 14241 Old Hwy 66	417-883-2355 1501 S Empire Ave	417-962-3126 11433 Dunn Dr	573-243-6052 3520 Matthew St	573-378-5474 900 Petty Dr	660-263-1213 1501 Rt DD	816-233-0248 12824 CR 352