



Missouri Smallflows Organization

OUTHOUSE POST

A Quarterly Publication

IN THIS ISSUE

What's Inside?
.....Page 1.....

Business Partnership
Program Supporters
.....Page 2.....

Note from the
President
.....Page 3.....

Getting To Know Board
Member Kendall Nakato
.....Page 8-9.....

MSO Legislative Update
.....Page 13.....

NOWRA
New Training Tools
.....Page 16-17

Listing of MSO Classes
.....Page 18.....

Listing of NOWRA Classes
.....Page 19.....

Thank You For A Great
2024 MSO Trade Show!
.....Page 21.....

OWTS Course for Realtors
.....Page 25.....



MSO Member Event - September 7, 2024
Join us for a Springfield Cardinals Baseball Game!
ATTEND THE GAME WITH YOUR GROUP!

UPDATE On MO
Legislation

**And Meet New
Board Member
KENDALL NAKATO**



**New Winners of the
MSO Annual Roe-D-Hoe
Competition!**



Missouri Smallflows Organization
2733 E Battlefield #132
Springfield, MO 65804

Phone: 417-631-4027

Email: contact@mosmallflows.org

MSO OFFICERS

Nick Dykes
President
(816) 580-4100

Jessi Wood
President-Elect
(816) 966-8885

Chris Northstine
Treasurer
(660) 224-9043

Seth Coggin
Secretary
(417) 291-5722

Michael Bowers
Past-President
(417) 868-4147

MSO BOARD OF DIRECTORS

Paul Ganey
(314) 973-0377

Eric Folks
(573) 751-6095

Kerry Clark
(660) 351-4696

Brenden Murphy
(636) 629-1788

Douglas Hurrelbrink
(417) 987-9914

Kendall Nakato
(417) 421-9527

Curtis Cluckey
(816) 769-0087

WELCOME TO OUR BUSINESS PARTNER PROGRAM SUPPORTERS

Thank you for supporting MSO's goals and our organization throughout the year.

DIAMOND BUSINESS PARTNER PROGRAM
Weber Industries

PLATINUM BUSINESS PARTNER PROGRAM
Missouri Water and Wastewater Products
Infiltrator Water Technologies
Innovative Pump Solutions
TG Rankin Company
Stewart Concrete
SI Precast

GOLD BUSINESS PARTNER PROGRAM
Residential Sewage Treatment Company
Allied Concrete Products
Ganey Engineering, LLC
JNM Technologies
Flo-Systems Inc.
Elgen Corp
RioVation
Geoflow
Jet, Inc.

If you are interested in being a part of our Business Partner Program check out the program on our website for more information.

INTERESTED IN MAKING YOUR COMPANY A BUSINESS PARTNER?

We appreciate all of our BPP members. This program enables you and your company to purchase exhibit space, newsletter advertising and your MSO membership all in one stop.

As a BPP, your company logo and link to your website will be on the MSO website. You have a certain number of membership slots to whom you can assign anyone. Our newsletter reaches over 400 people quarterly and the list is growing. We send our newsletter via email and mail to some patrons.

We have varying levels of sponsorships based on your need. You should check out our BPP webpage (www.mosmallflows.org) for the full details.

If you would like a copy of the brochure with prices and details, you may always contact Tammy Trantham at contact@mosmallflows.org.

Let us help you get your company name out to our membership and more. Thank you for supporting Missouri Smallflows.

A NOTE FROM THE PRESIDENT

MSO Members,

I would like to introduce myself; my name is Nicholas Dykes. I'm an Onsite Installer from the Kansas City area. I work with my father and many other good men & women at our family business, Dykes Construction. Our primary focus is new installations and replacement systems. However, we offer many other services, such as inspections, pumping, system service, distribution of ATU components, and excavating. I am the third generation in this business and pride myself on providing the highest quality work at an honest price.

Two and a half years ago, I joined the MSO Board with a goal of making an impact towards growing our industry in the state of Missouri, finding innovative ways to attract new professionals to the field, and giving back to the industry that has done so much for me. Shortly thereafter, I became an educator and began teaching classes in Missouri for MSO. I have also had the privilege of traveling our nation, speaking to other state groups, and at NOWRA. This winter I was elected president of MSO, for which I am honored. I intend to fulfill this role as a trusted servant of this organization with the members' best interest at heart, and the goals mentioned above.

I hope you all are off to a good start this work season; mother nature has been kind to us thus far, and I am hoping this pattern continues. As we get back into the swing of things, let's all follow best practices, take care of the communities we serve, and make safety on our jobsites a priority. This is the first step in growing our industry and our businesses.

For those of you that missed the MSO annual conference this year, it was an excellent show. We had a wide array of exciting presenters, many new topics, the forever famous Roe-D-Hoe, and countless exhibitors with their products on display. I am looking forward to next year's conference already. Keep in mind over the coming year that any suggestions you have for class topics can be passed onto the board. This helps us bring relevant classes and courses to you. We have another membership event planned at the Springfield Cardinals ball field coming up this fall. This is an excellent opportunity for fellowship. There is more info in the newsletter about this! Last year it was great fun, and I hope to see many of you there this year.

The Board had the Annual Strategic planning meeting in March. We elected officers at this time, set goals for the future, and came together to strategize for the coming year. Our primary focus for this year is to expand the number of courses we have to offer the membership for CEU's in person and online.

This organization is incredibly strong, and I would like to thank our Executive Director, Tammy Trantham, for all that she does. We are lucky to have her on our side. I would also like to thank our past board members, and current board members. They are all busy professionals but find time to serve and give back. With that said, we have many committees (i.e., Education, Membership, Conference established. Any member interested in joining these committees is welcome, and your further investment in our organization would be greatly appreciated. Please feel free to reach out if you're interested in getting involved!

Sincerely,
Nicholas Dykes





There when you need us most

Product Knowledge Huge Inventory Local Deliveries



Pumps | Tanks & Basins | Pump Stations
Residential & Commercial Treatment
Controls | Drain Field Products | EZ-Pull

Our Partners



INFILTRATOR®
water technologies



Our Team

Webtrol.com

St. Louis Chris: 800-769-7867
West Plains Christina: 417-256-1255

Lake of the Ozarks Zach: 573-374-6444
Arkansas & SW MO Raymon: 479-640-0052



MSO Member Event - September 7, 2024

Join us for a Springfield Cardinals Baseball Game!

ATTEND THE GAME WITH YOUR GROUP!

MSO Has 30 Tickets Available For Members To Purchase

You may bring your spouse and family
(One adult must be MSO member)

Tickets are \$30/ person
Ticket price includes 4 drink vouchers
and access to select food items

LOCATION

Champion's Club - First Base Side of the field in a Suite Box!

Contact Tammy at MSO to purchase tickets
Email: contact@mosmallflows.org
Phone: 417-631-4027

Springfield Cardinals Polices

Cashless Stadium - Bring your card to purchase items

Clear Bag Policy - No backpacks

Parking - \$10 in the lot south of the stadium
(cash and card accepted)

See the complete list here:

<https://www.milb.com/springfield/tickets/know-before-you-go>

Wastewater Solutions

Treatment

Dispersal

Storage

Pumping

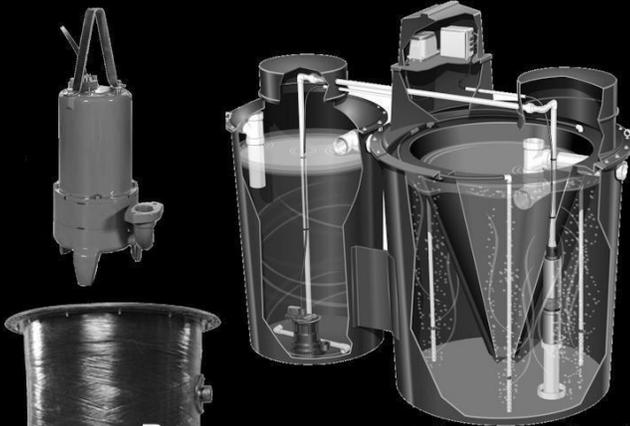

Pressure Sewer Systems



SJE RHOMBUS

Pump Controls



Effluent Pumps

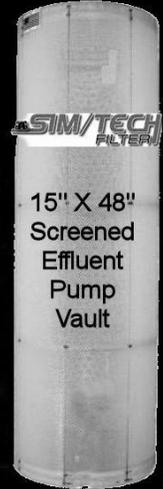

SIM/TECH FILTER

15" X 48" Screened Effluent Pump Vault



UV Disinfection



SJE Rhombus Solar Powered Alarm

Polylok D-Box

Polylok PL122 Effluent Filter

NSF

Salcor 3G UV

Drip Irrigation



STEP vaults

Snyder Septic Tanks Poly Nexgen D2



TG Rankin Co

233 Chesterfield Ind Blvd
Chesterfield, Mo 63005
636-532-4555
636-532-4716 fax

1801 Jasper St
N Kansas City, MO 64116
816-421-4646
fax 816-421-6120

www.tgrankin.com

Residential

Commercial

Municipal

INNOVATIVE PUMP SOLUTIONS

PHONE (417) 343-2211 FAX (417) 212-5346

ROGERSVILLE, MO

PROUDLY SERVING MISSOURI, ARKANSAS & ILLINOIS

PUMPS -- BASINS -- CONTROLS -- VFD'S
SWITCHES -- CONSTANT PRESSURE SYSTEMS
PHASE CONVERSION -- VOLTAGE DOUBLING

ORDERS IN BY 1:30 SHIP SAME DAY ON STOCKED ITEMS



Franklin Electric



Getting To Know Board Member Kendall Nakato

Dear Members,

It is with pleasure that I extend warm greetings to each of you in within the Missouri Smallflows Organization. As a newly appointed member of the Board of Directors, I am deeply honored to have the opportunity to serve alongside esteemed colleagues dedicated to advancing the field of on-site wastewater treatment. My goal is to help get more young professionals involved in the industry.

I recently gained my credentials as a site/soil evaluator (second half of 2023). I also hold an Inspector/Evaluator and Advanced Installer credentials. I operate under a business called Nakato Environmental, LLC.

Licenses and Registrations:

- **Licensed On-Site Soil/Site Evaluator**
- **Licensed OWTS Inspector/Evaluator**
- **Registered Advanced OWTS Installer**
- **Registered Water (Fluorescent Dye) Tracer**
- **Certified Wastewater Treatment Operator (DNR Class D)**
- **Certified Drinking Water Treatment Operator (DNR Class D)**
- **Certified Drinking Water Distribution Operator (DNR Class I)**

Allow me to introduce myself. My background is in environmental science and compliance. In my current role I serve as an Environmental, Health, and Safety Coordinator at AMPROD. Before AMPROD, I was an Environmental Scientist at Environmental Works, Inc. Prior to that I interned with Green County Resource Management – Environmental Division under Michael Bowers. My professional journey has been focused on helping businesses maintain compliance with environmental regulations.

In addition to my professional endeavors, I am currently pursuing dual master's degrees at Missouri State University in Plant Science and Natural and Applied Sciences (Geology). My research focus, centered on the interplay between hydrogeology, soil science and wastewater treatment, which holds profound implications for our industry. Specifically, my thesis project seeks to address the challenge posed by perched water tables in on-site wastewater treatment systems, with a keen emphasis on the feasibility of modified conventional treatment methods.

The research is aimed at measuring the extent that interceptor drains lower the seasonal perched water table. Ideally, this would help to determine if the water table is low enough to allow for a gravity flow and soil treatment of the effluent. If this research is successful, this could help to support the use of conventional treatment on sites which have a limitation due to the depth to the seasonal water table.

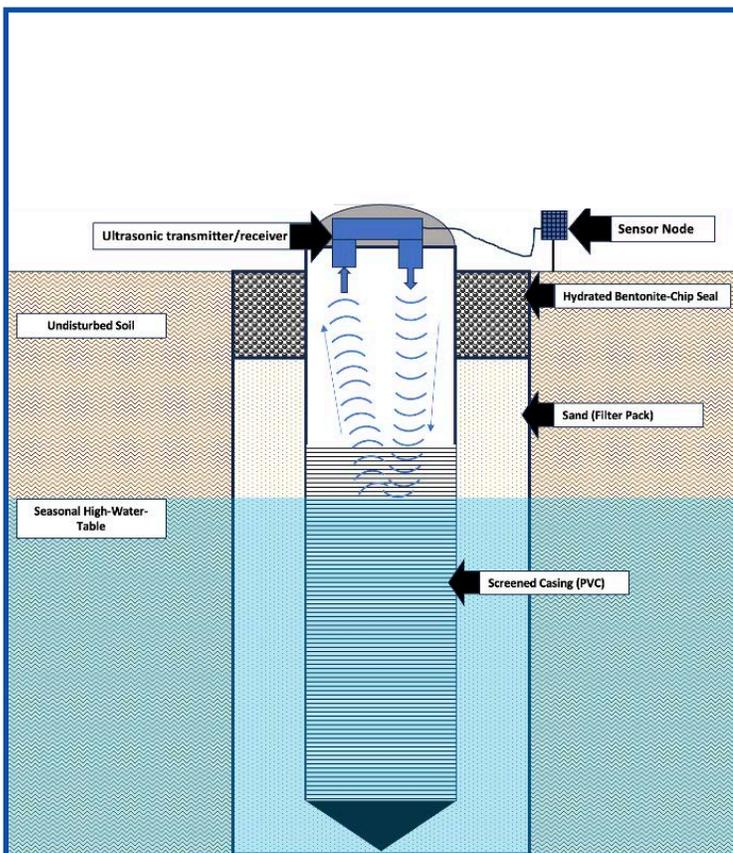
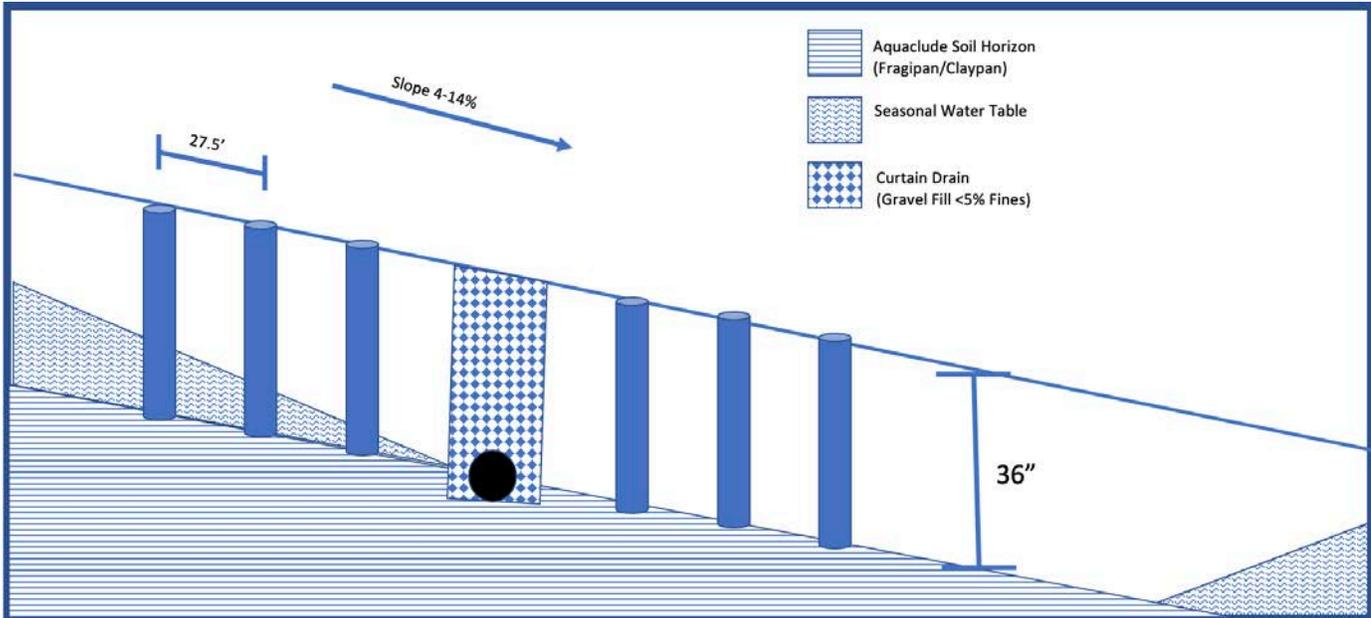

Central to the success of this project is the selection of sites featuring fragipan/claypan soils, which are prevalent in our region. These soils, characterized by their high compaction and seasonal water table fluctuations, present a unique set of challenges that demand innovative solutions. By leveraging insights from esteemed researchers such as Brad Lee, Don Franzmeier, Phillip Owens, and Don Jones at Purdue University, I aim to enrich our understanding of these complex soil dynamics and their implications for wastewater treatment.

Warm regards,
Kendall Nakato
Nakato Environmental, LLC



Recognized as the Leader
in Precast Concrete Tanks
& Specialty Products

Over
50+ Years
EXPERIENCE



**Residential & Commercial
Waste Water Treatment Specialist**

Design, Build & Implement
12,000 GPD to 96,000 GPD

Tony@precasttanks.com | 314-267-5375



Aerobic Septic Systems
Class 1 Aeration 500 GPD to 1000 GPD

www.precasttanks.com



Install A Hoot Don't Pollute

HOOT SYSTEMS, LLC.

www.hootsystems.com

Call toll-free
888.878.HOOT

LA- Hoot

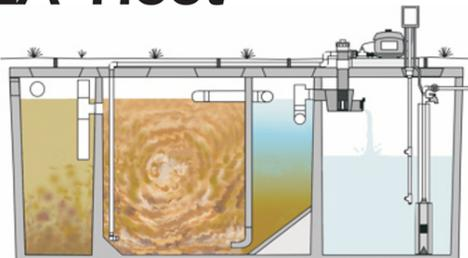

Hoot Systems Local Dealer



314-267-5375

Hoot Systems Offers:

- 4 Models of NSF Standard 40 Systems
- 2 Models of NSF Standard 245 Systems
- Integrated Drip Packages
- Commercial & HS Treatment Systems for C-Stores, Restaurants, RV Parks, Schools, Churches and Shopping Centers

Please contact your Local Dealer -
Tony Champion or the Hoot Corporate
Office for more details!

Break Free!

Drip solves many problems plaguing traditional drainfields.



WaterflowPRO®

- Nano-Rootguard® keeps roots out
- Geoshield® lining stops bioslime
- 16mm tubing with cylindrical emitters



New!



WaterflowECO®

- Geoshield® lining stops bioslime
- Tru17mm tubing with flat emitters
- Made in the USA

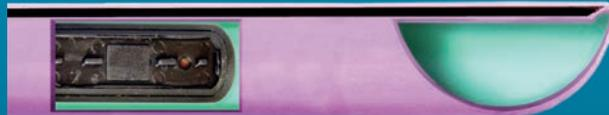

Geoflow

800.828.3388 ■ geoflow.com





Manufacturers of
STEPS-SEPTIC TANKS
PARKING CURBS-SPLASH BLOCKS-GREASE INTERCEPTORS
AIR CONDITIONER BASES-PRECAST CONSTRUCTION ITEMS
CONCRETE FENCE



Does your customer have a grinder pump problem?

Need a partner for servicing or replacing grinder pumps when your customer calls? Call Flo-Systems to help you out. Let us Help You service your customers.

If you need a helping hand when a customer calls about their grinder pump, let us go make the service call for you. We can be an extension of your service crew. Let Flo-Systems provide your client with with an Upgrade from E/One, We can perform the work, and do the billing for you. Call to discuss the details

Contact your local sales representative:
Flo-Systems Process Equipment, Inc.
905 Cherry Ln • Troy, IL 62294
618-667-7890 • www.flosystems.com
Dan Hufker 618-979-0884



MSO Legislative Update

MSO Members,

MSO has been watching HB 2083 move through the Missouri House of Representatives. The bill is sponsored by Representative Kurtis Gregory from the 51st District. This bill can be seen on the MO House of Representatives website. At the time this article was written, we were waiting for the bill to be read on the House floor.

HB 2083 will make a few changes to our statute. First, it will phase out percolation testing by January 2025. We realize this is a change in our Missouri industry, but many counties already do not accept percolation tests, rather, they require a soil morphology report. A soil morphology report must be completed by a certified Onsite Soil Evaluator (OSE). The variability in percolation testing makes it difficult to have an accurate test in different parts of the year in Missouri soils. By removing the option for percolation testing, our industry will raise the standards to match other states and most counties for accurate evaluations of soils for onsite wastewater treatment.

MSO realizes that Missouri has a shortage of OSE professionals. We have already begun the process of developing an OSE training program to introduce more professionals to the trade. This course will also prepare them for the written exam and field exam. Currently, there is no training course for these professionals from DHSS. We have partnered with DHSS to develop this course, so we have a better opportunity to train professionals to examine soils with onsite wastewater treatment as the main determining factor. This course will most likely pilot in 2024. We will open it up to certified OSE professionals for continuing education so we can acquire more feedback on the components. After that, we will begin to reach out to various trades and host this class to interest more in the field.

The other facet of HB 2083 is to remove the verbiage that sets the permit application fees to \$90. Every one of us knows that you can't do much for \$90 anymore. The change in the verbiage will allow DHSS and local regulatory agencies to set permit fees to "reasonable fees" and "set at a level to produce revenue that shall not exceed the cost and expense of administering the provisions of sections 701.025 to 701.059." This is important since many of our local agencies have deferred to the state for regulatory authority since the fees will not cover staff time. We hope that if this passes, we can gain more counties with local authorities to help our industry with faster permitting processes all around.

I want to thank those of you that submitted testimony in support of the bill back in February. MSO appreciates your support. If you have any questions about this bill, please reach out to MSO via email or phone.

Best regards,

Tammy Trantham

Tammy Trantham
Executive Director



RENEW YOUR MSO MEMBERSHIP!

Call or email the MSO office to check your membership status



Membership only costs \$140 each year!

Thank you for supporting MSO!



STEWART Concrete Products

Proudly providing Missouri and the surrounding region with quality wastewater products



INFILTRATOR
water technologies

Lincoln, MO
(800) 743-0304
Webb City, MO
(888) 673-3321

norweco

*Engineering the future of water
and wastewater treatment*

Halfway, MO
(800) 798-0183
Lowell, AR
(479) 659-8830

ZOELLER 
PUMP COMPANY

Spokane, MO
(877) 777-4302
Nevada, MO
(800) 743-0305

ORENCO ONSITE PRODUCTS

Built to work together. **Built** for the job. **Built** to last.



Lids, Risers & More

- Lids that don't warp or collapse
- Risers that don't deform
- Riser safety grates
- Riser/tank adapters
- Adhesives and dispensing guns
- All parts watertight
- Standard and custom sizes

Filters & Pump Vaults

- Filters that go longer between cleanings
- Pumps that last for decades
- Pump vaults for any kind of tanks
- Complete pumping systems



Controls

- Complete panel kits with floats
- Touch-safe controls
- Name-brand parts
- Resettable breakers
- Long-lasting contractors, millions of cycles
- UL, UL-C, CE listings; UL Type 4 rating



Missouri Water & Wastewater Products, Inc.
515 Old South 5, Camdenton, MO 65020
573-346-9991 • sales@mwwp.biz

Seth A. Coggin, P.E. • 417-291-5722
sethcoggin@mwwp.biz



814 Airway Ave., Sutherlin, OR 97479, USA
1-800-348-9843 • 1-541-459-4449 • www.orencosystems.com

NOWRA And Partners Introduce New Training Tools Aimed At Educating Septic System Users

By Jim Kneiszel

Reprinted from Onsite Installer Magazine February 2024

Sometimes onsite installers get so caught up in obtaining continuing education credits for their crews and efforts to learn new treatment technologies that they can forget another important role they play in wastewater training: schooling septic system users.

After all, unless the homeowners in charge of their own private decentralized wastewater systems understand how they work and realize the importance of routine maintenance, wastewater professionals will have a tough time providing essential services. While installers have voiced their frustrations to me over having to cover Wastewater 101 for every fresh and new customer, that's really quite an important aspect of their job.

Sure, you might thrive on excavating for and placing septic tanks, laying out piping and drainfields, and employing all of the latest advanced components to complete an effective treatment system. But before delivering equipment and materials to the work site, you need to sit down with your customers at the dining room table and declare that class is in session.



But one challenge is how to best cover highly technical subject matter that has taken you many years to master yourself. I have heard from installers who sometimes struggle with customer education because A) they aren't educators by trade, B) they have no idea of the learning abilities and backgrounds of their customers, and C) they got into this business because they liked to be down in the trenches and that's where they want to spend their time.

But the lesson quickly learned is that regular communication with customers goes with the territory. And National Onsite Wastewater Recycling Association leaders clearly know that. This is apparent because NOWRA — in partnership with the U.S. Environmental Protection Agency and the Rural Community Assistance Program — recently launched a comprehensive homeowner training program installers can share with their onsite system users.

After all, unless the homeowners in charge of their own private decentralized wastewater systems understand how they work and realize the importance of routine maintenance, wastewater professionals will have a tough time providing essential services. While installers have voiced their frustrations to me over having to cover Wastewater 101 for every fresh and new customer, that's really quite an important aspect of their job.

Sure, you might thrive on excavating for and placing septic tanks, laying out piping and drainfields, and employing all of the latest advanced components to complete an effective treatment system. But before delivering equipment and materials to the work site, you need to sit down with your customers at the dining room table and declare that class is in session.

But one challenge is how to best cover highly technical subject matter that has taken you many years to master yourself. I have heard from installers who sometimes struggle with customer education because A) they aren't educators by trade, B) they have no idea of the learning abilities and backgrounds of their customers, and C) they got into this business because they liked to be down in the trenches and that's where they want to spend their time.

But the lesson quickly learned is that regular communication with customers goes with the territory. And National Onsite Wastewater Recycling Association leaders clearly know that. This is apparent because NOWRA — in partnership with the U.S. Environmental Protection Agency and the Rural Community Assistance Program — recently launched a comprehensive homeowner training program installers can share with their onsite system users.

The free course, including the informative Onsite Wastewater Treatment System User Guide, is available now at [nowra.org](https://www.nowra.org). The training covers everything from flush to final treatment using terminology, simple graphics, detailed photos, videos and charts that are easy for the layman to understand.

The materials are designed for onsite professionals to share in seminars with homeowner groups, health officials, Realtors or any interested parties who would like to learn how a private onsite wastewater treatment system functions. The training sessions are broken down into four modules: overview of sewage treatment and typical OWTS, overview of management, home management tips and troubleshooting.

The materials include slides with speaker notes and recommended activities to get attendees involved with the coursework. An online version of the training program and a Spanish translation are in the works for 2024, according to information provided by NOWRA.

The original article and additional materials can be found at
<https://www.onsiteinstaller.com/editorial/2024/02/class-is-in-session-for-your-customers>

LISTING OF MSO CLASSES

PLEASE REGISTER AT LEAST TWO WEEKS PRIOR TO THE CLASS!

Call our office to register at 417-631-4027

Or find the Registration Form on our website: www.mosmallflows.org

<p>Troubleshooting Onsite Systems Location: Jefferson City, Cole County Health Dept. Date: April 23, 2024 Full day class: 8:30 AM - 4:00 PM DHSS General CEUs: 6.0 Select: Basic: 6.0, Advanced: 6.0, Inspector: 6.0, OSE: 0</p> <p>Member price: \$130 Non-member price: \$200</p>	<p>Drip Irrigation Location: Jefferson City, Cole County Health Dept. Date: April 24, 2024 Full day class: 8:30 AM - 4:00 PM DHSS General CEUs: 6.0 Select: Basic: 3.5, Advanced: 6.0, Inspector: 6.0, OSE: 3.5</p> <p>Member price: \$130 Non-member price: \$200</p>
<p>Types of Drainfields & Water Management Location: Imperial, Ganey Engineering Date: May 14, 2024 Full day class: 8:30 AM - 4:30 PM DHSS General CEUs: 7.5 Select: Basic: 5.5, Advanced: 6, OSE: 1 Member price: \$130 Non-member price: \$200</p>	<p>What's in my Yard? Location: Imperial, Ganey Engineering Date: May 15, 2024 Full day class: 8:30 AM - 4:30 PM DHSS General CEUs: 6.5 Select: Basic: 5.5, Advanced: 5.5, Inspector: 1.5, OSE: 1 Member price: \$130 Non-member price: \$200</p>
<p>Types of Drainfields & Water Management Location: Liberty, Clay County Health Department Date: May 21, 2024 Full day class: 8:30 AM - 4:30 PM DHSS General CEUs: 7.5 Select: Basic: 5.5, Advanced: 6, OSE: 1 Member price: \$130 Non-member price: \$200</p>	<p>Onsite Pumps, Panels & Electrical Location: Liberty, Clay County Health Department Date: May 22, 2024 Full day class: 8:30 AM - 1:30 PM DHSS General CEUs = 4.0 Select: Basic: 3.5, Advanced: 3.5, Inspector: 3.5, OSE: 0 Member price: \$130 Non-member price: \$200</p>
<p>Inspecting Tanks, Lagoons & LPP Location: Camdenton, Mid-County Fire Department Date: June 5, 2024 Full day class: 8:30 AM - 3:30 PM DHSS General CEUs: 5 Select: Inspector: 5 Member price: \$130 Non-member price: \$200</p>	<p>Trickling through Media Filters Location: Camdenton, Mid-County Fire Department Date: June 6, 2024 Full day class: 8:30 AM - 4:00 PM DHSS General CEUs: 6 Select: Basic: 0, Advanced: 6, Inspector: 4, OSE: 0 Member price: \$130 Non-member price: \$200</p>

More classes are being scheduled.

See our online classes available on our website: www.mosmallflows.org

Seminar refund policy available online



Missouri
Smallflows
Organization



Online Courses available for CEUs in Missouri!

Continue your education from the comfort of your office or home!

In partnership with NOWRA, Missouri Smallflows Organization has online courses available for onsite wastewater professionals to earn more CEUs for their license renewal. You can read all about these courses on our website with CEU summaries.

<http://www.mosmallflows.org/online-classes.html>

As a member of MSO, you save \$25/credit hour for online classes!

Be sure your membership is up-to-date! Contact our office!

Phone: 417-631-4027 or email: contact@mosmallflows.org

To see complete course listings go to the MSO website.

<http://www.mosmallflows.org/online-classes.html>

NOWRA Installer Academy Module	8 different classes available Select classes that you are interested in!
NOWRA Troubleshooting Module	9 different classes available Select classes that you are interested in!
NOWRA Design Course Overview - Part 1	7 different classes available Select the classes that you are interested in!
NOWRA A to Z Module	3 different classes that you can bundle for an 8 hour course OR Select the classes you are interested in!
NOWRA Onsite Mega 2020	6 different classes from the 2020 NOWRA Virtual Conference. Only available for a limited time!

We have something new to show the Show-Me State!



- Simple Installs
- Simple Treatment & Disposal • Simple maintenance • Flexible design options
- Perfect for small and complicated sites as well as commercial operations

*Ask us about
Training Seminars
in your area!*

eljen
CORPORATION

Innovative Onsite Products and Solutions Since 1970

800-444-2359

www.eljen.com



Thanks for a great 2024 MSO Conference & Trade Show!

In January, MSO hosted its annual conference and trade show for over 275 attendees. The event was well attended as temperatures were well below zero and no one wanted to work outside. The conference boasted a great number of excellent speakers. Many of the attendees stated that this was one of the best educational shows they've been to yet.

A big thank you to our speakers for the Pre-Conference on January 15. The morning session centered around sand-based systems and many excellent questions were asked about these types of treatment options. The afternoon session refreshed on septic tank installation tips and preparing your site for tank drop-off. All of the speakers were great; Kevin Moreau, Drew Nickoli, Jeff and Jay Julien, Sean Bauer, Curtis Cluckey, and Rick Kirkpatrick.

Another big thank you to our Keynote Address speakers. It was great to have Mark Gross visit us to talk about the Closing America's Access Gap Community Initiative. Then Nicholas Dykes and Jessi Wood took the stage to talk about professionalism in our industry. They did a fantastic job of showing where we need to raise ourselves to promote the industry.

Thank you to all the exhibitors who attended and supported the show as well. Our exhibit hall had many companies in attendance for our attendees to visit with. This show would not be possible without you.

The Roe-D-Hoe was a great success! We have new winners this year!

Congratulations to our Champions!

1st Place:

Anthony Dirks, *Gallatin, Missouri*

2nd Place:

Robert Mahoney, *Arnold, Missouri*

3rd Place:

Dan Boman, *Rosebud, Missouri*



Mark your calendars for January 20-22, 2025, in Columbia.

We'll see you at the next show!



Flagg-Air® 340HT Series

The Flagg-Air® shaft-style septic aerators are compatible replacements for OEM aerators in Jet® and Norweco Singlair®* septic systems. Powder-coated steel brackets fit either the 10-inch Jet® or the 12-inch Norweco Singlair® tank openings.

- Proven performance in OEM tanks
- High-torque, continuous duty motor
- Made in the USA
- 2-Year limited warranty
- Trusted by professionals for over 30 years!

ORDER TODAY!



on orders over \$30

Special contractor pricing available!

(800) 778-1540 | www.septic-tank-parts.com
7059 Highway 47 Union, MO 63084

Flagg-Air® 340HT-J Flagg-Air® 340HT-N

12-inch

14-inch



FA 340HT-N
Alternative for all
Norweco® models

FA 340HT-J
Alternative for all
Jet® models



*Norweco Singlair® is a registered trademark of Norwalk Wastewater Equipment Company, Inc. Jet® is a registered trademark of Jet, Inc. All original manufacturer's names, drawings and part numbers are used for identification purposes only and we are in no way implying that any of our products are original equipment parts, or are affiliated with, or endorsed or approved by the original manufacturers.

Visit SepticTankParts.com for our entire line of septic pumps, aerators, rebuild kits, and more!



WHIRLWIND™
Linear Air Pumps



WHIRLWIND™
Regenerative Blowers



MAX FILTER SOCKS
(30-PK)



MAXAIR500™
Submersible Aerator

Residential Sewage Treatment Company

12800 2nd Street

PO Box 248

Grandview, MO 64030-0248

Phone: 816-966-8885

Fax: 816-966-8778

Email: info@residentialsewage.com

Website: www.residentialsewage.com

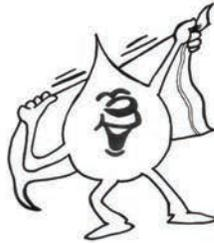

We specialize in sales, design, and service of alternative onsite wastewater products.

Distributing quality products from these manufacturers and more!

Norweco, Inc.

Allied Concrete Products

Infiltrator Water Technologies

Liberty Pumps

Geoflow, Inc.

SJE Rhombus

GAG Sim-Tech

K-Rain

Call our office today for a quote!

816-966-8885

Like us on Facebook! 

Your alternative wastewater specialist!



MODEL 952

- UL listed as a NEMA 6p enclosure (watertight submergence test)
- Install directly in ground or in pump tank on effluent line
- Complete disinfection without the use of chemicals
- Hermetically sealed electrical components
- High capacity disinfective reservoir
- Kapton seals improve serviceability
- Rated treatment of 10 gallons/min

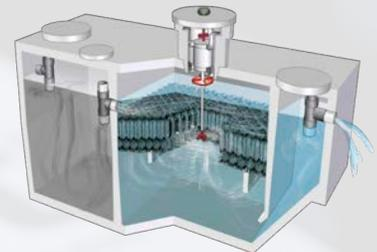
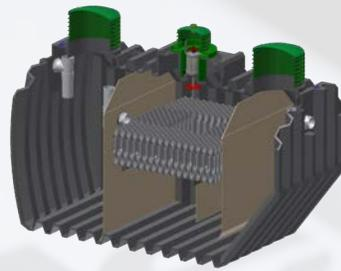

RESIDENTIAL & COMMERCIAL TREATMENT PLANTS

- Concrete and rugged polyethylene material
- 500-1500 GPD Residential Systems
- 1500-300,000 GPD Commercial Systems
- Up to 800 GPD in plastic design
- A single moving part
- Innovative design for easy system servicing
- No filters to clog
- Lifetime exchange program

ACCU-TAB WASTEWATER TABLETS

- U.S. made, recognized global brand with no imported ingredients
- Chlorine tablet with beveled edges to minimize wicking
- Consistent chlorine strength for reliable dosing control
- No measuring, mixing, or spilling of chemicals common with granular and liquid chlorine
- Stearate free formula with balanced pH



www.jetincorp.com
440.461.2000



Failing Septic System?

Need Financial Assistance?

Homeowner assistance is now available for septic remediation in select watersheds around Harry S. Truman Lake, Lake of the Ozarks, Pomme de Terre Lake, Lake Niangua, and Table Rock Lake!! Eligible homeowners can receive up to 100% reimbursement for remediating their septic system!

If you have a failing septic system or one in need of repair, you may qualify for financial assistance if this criteria is met:

- Single-family, residential home
- Household income less than \$61,000
- Existing system, new builds do not qualify
- Home must be located in a priority watershed
- Homeowner must have proof of failing system



For more information, please visit the
the H2Ozarks website at
www.h2ozarks.org/moseptic
or follow the QR code.



This project is made possible by pass-through funding from the USEPA to the Missouri Department of Natural Resources, through the 2022 Clean Water State Revolving Fund Capitalization Grant. The US EPA has provided 100% of the \$2,575,000 award in federal funds.

Onsite Wastewater Treatment Systems for Realtors Course scheduled in Springfield for May 2

In February, we helped host a course for realtors about onsite wastewater treatment systems. Thank you to our partners for helping us put on this event: Stronghold Inspections. Since this time, MSO has become an accredited school with the Missouri Real Estate Commission (MREC) and has received approval to host classes for realtors. We have scheduled another one so please spread the word to anyone you may know.

Event Hosts: James River Basin Partnership, Missouri Smallflows Organization, and The Watershed Committee of the Ozarks.

Place: Praise Assembly, 3535 N. Glenstone Ave, Springfield, MO

Date: Thursday, May 2, 2024

Time: 8:00am - 1:00pm

Admission: \$15 for lunch and continuing education credits; register below.

The James River Basin Partnership, Missouri Smallflows Organization, and the Watershed Committee of the Ozarks will hold an Onsite Wastewater Treatment System (OWTS) Inspection/Evaluation for Real Estate Professionals Workshop on Thursday, May 2, 2024, at Praise Assembly, 3535 N. Glenstone Ave in Springfield, from 8:00 am to 1:00 pm.

The workshop will include a visit to the Greene County Onsite Wastewater Training Center and will give developers and real estate professionals the opportunity to learn more about onsite wastewater treatment systems that may be installed at properties they are listing for sale.

When you register, please put your Missouri Real Estate Licensee Number in the notes; otherwise, MSO will contact you via phone to get this information prior to the class.

Funding for this workshop is provided by the Greene County Environmental Division. Course Host is Missouri Smallflows Organization (School #95000). Course has been approved by MREC for 3 Elective CEs.

Register at this website: <https://www.jamesriverbasin.com/owts-workshop>

Deadline to register: April 30, 2024





GANEY

ENGINEERING

Protecting Today's Ground Water for Tomorrow

3405 Old State Road M, Imperial, MO 63052
 314-973-0377 ganeyengineering@yahoo.com

- septic system design
- sewer system design
- septic system evaluations
- onsite wastewater consulting
- Aeration Unit Supplier
- storm water consulting



BioMaze® Model BM2624
0-750 GPD



BioMaze Pod with
Treatment Biofilm



BioMaze® Drainfield Rejuvenation Fixed Film Media (FFM) ATU Conversion Kit

Quickly Recovers Biomat Clogged Drainfields!

Easily installs into virtually any septic tank

Simply lower the BioMaze™ self-positioning pods into the septic tank through a riser. Connect air line between the air pump and diffuser pod(s). Plug into 120 Volt outlet. The septic tank is now a Biofilm Reactor typically making single digit BOD/TSS

What the Researchers are saying:

“Aerobic treatment units (ATUs) are systems that use natural processes to treat wastewater and are frequently used to renovate biologically clogged, failing septic tank-soil absorption units.”

West Virginia University - NESU.WVU.EDU Winter 2005 Vol. 16, No

Visit RioVation.com for more information and to place orders

See our Videos at youtube.com/@riovation

Phone: (903) 215 8855 * Patents Pending *



Optional Septic Tank
Level Control



Resulting Effluent
Clear and Odorless



INFILTRATOR
water technologies

Engineered For Performance



ADVANCED **ENVIRO**SEPTIC™

Passive Onsite Wastewater Treatment Systems

Combined Treatment and Dispersal

- Treats and disperses wastewater in the same footprint
- Flexible configurations for sloped or curved sites
- Testing in accordance with NSF/ANSI 40 for treating domestic strength wastewater to Class I levels
- No electricity, replacement media or additional maintenance required



Residential Advanced Wastewater Treatment Systems

Innovative approach to onsite wastewater disposal where nitrogen reduction is required.

- Nitrogen reduction greater than 50%
- The fixed film process suitable for continuous or intermittent use
- Industry proven solution with both NSF/ANSI 40 and 245 certifications
- Easy to maintain – no mechanical parts



Certified to
NSF/ANSI Standards 40 & 245



CALL FOR INFORMATION AND A DISTRIBUTOR NEAR YOU!

Curtis Cluckey • (816)769-0087 • ccluckey@infiltratorwater.com
Rick Kirkpatrick • (860) 575-8020 • rkirkpatrick@infiltratorwater.com



**Missouri
Smallflows
Organization**

2733 E Battlefield #132
Springfield, MO 65804

PRSRT STD
US POSTAGE
PAID
SPRINGFIELD, MO
PERMIT #176



YOUR TOTAL WASTEWATER SOLUTION
888-262-7383

Residential

Septic tanks
Aerobic Treatment
Drip Irrigation Packages
Pumps and Controls
Lids & Risers
Infiltrator Chambers



Commercial

Treatment up to 100,000 gpd
Custom Cast STEP Projects
Sand Filter Components
Grease Interceptors
Commercial Size Castings
Call Sean @ 573-280-4130

Grandview, MO	St James, MO	Springfield, MO	Mtn Grove, MO	Jackson , MO	Versailles, MO	Moberly, MO	St Joe, MO
816-966-9000 11919 Cartwright	573-265-7028 14241 Old Hwy 66	417-883-2355 1501 S Empire Ave	417-962-3126 11433 Dunn Dr	573-243-6052 3520 Matthew St	573-378-5474 900 Petty Dr	660-263-1213 1501 Rt DD	816-233-0248 12824 CR 352