



Missouri Smallflows Organization

OUTHOUSE POST

A Quarterly Publication

Summer 2023

IN THIS ISSUE

- What's Inside?Page 1.....
- Business Partnership Program SupportersPage 2.....
- Note from the Executive DirectorPage 3.....
- Our Current and Future NeedPages 5.....
- Onsite Wastewater Training Center DonationPage 8-9.....
- 2023 Septic RemediationPage 10.....
- NOWRA ConferencePage 13.....
- Listing of MSO ClassesPage 18.....
- Online Class InformationPage 22.....
- Tool Box TalkPage 26.....

REGISTER NOW!

Upcoming MSO CLASSES AVAILABLE

Online Classes Available For After Work Hours!



RAISING THE BAR TRAINING CENTER DONATION



2023 SEPTIC REMEDIATION in Greene County



MSO Member Event 9/9/23 SPRINGFIELD CARDINALS



Onsite Wastewater Mega-Conference | 2023 Hampton, Virginia
NOWRA | NAVT | EOWA | WWA



OUR CURRENT & FUTURE NEEDS

NOWRA Conference Hampton, Virginia

And MORE!



Missouri Smallflows Organization
2733 E Battlefield #132
Springfield, MO 65804

Phone: 417-631-4027

Email: contact@mosmallflows.org

MSO OFFICERS

Michael Bowers

President
(417) 868-4147

Sean Bauer

Vice President
(573) 280-4130

Jessi Wood

Treasurer
(816) 966-8885

Seth Coggin

Secretary
(417) 291-5722

MSO BOARD OF DIRECTORS

Paul Ganey
(314) 973-0377

Eric Folks
(573) 751-6095

Kerry Clark
(660) 351-4696

Nick Dykes
(816) 580-4100

Larry LaFollette
(417) 736-4155

Rick Wilcockson
(636) 358-7797

Chris Nothstine
(660) 224-9043

WELCOME TO OUR BUSINESS PARTNER PROGRAM SUPPORTERS

Thank you for supporting MSO's goals and our organization throughout the year.

DIAMOND BUSINESS PARTNER PROGRAM

Webtrol
SI Precast

PLATINUM BUSINESS PARTNER PROGRAM

TG Rankin Company
Infiltrator Water Technologies
Stewart Concrete
Missouri Water and Wastewater Products
Innovative Pump Solutions

GOLD BUSINESS PARTNER PROGRAM

Jet, Inc.
Residential Sewage Treatment Company
Allied Concrete Products
Flo-Systems Inc.
Ganey Engineering, LLC

If you are interested in being a part of our Business Partner Program check out the program on our website for more information.

INTERESTED IN MAKING YOUR COMPANY A BUSINESS PARTNER?

We appreciate all of our BPP members. This program enables you and your company to purchase exhibit space, newsletter advertising and your MSO membership all in one stop.

As a BPP, your company logo and link to your website will be on the MSO website. You have a certain number of membership slots to whom you can assign anyone. Our newsletter reaches over 400 people quarterly and the list is growing. We send our newsletter via email and mail to some patrons.

We have varying levels of sponsorships based on your need. You should check out our BPP webpage (www.mosmallflows.org) for the full details.

If you would like a copy of the brochure with prices and details, you may always contact Tammy Trantham at contact@mosmallflows.org.

Let us help you get your company name out to our membership and more. Thank you for supporting Missouri Smallflows.

A NOTE FROM THE EXECUTIVE DIRECTOR

MSO Members,

I always thought the summer was a good time for me to catch up while most of you are in the field. However, I don't really have downtime anymore. Our industry has grown so much in the past 5 years that this really is a year-round job. I enjoy every day of it, and I hope you enjoy working in this field too.

MSO has partnered with James River Basin Partnership, Watershed Committee of the Ozarks and H2Ozarks to bring a little funding to Greene County residents for septic remediation. You can read more details on the project on page 10 of the newsletter. The project is funded by Greene County ARPA funds. We don't expect the funds to last long so if you have any low-income families that need some septic system remediation in Greene County have them apply soon.

We are also excited to bring a new Member Event. I hope you join us on September 9 at a Springfield Cardinals baseball game. We have 30 tickets available for purchase. This event is reserved for members so you need to be a current MSO Member but then you can bring your spouse or family. Tickets are \$30 each but we are seated in the Redbird Roost. Ballpark food is provided! Join us for baseball and fireworks!

I also want to give a big THANK YOU to Colin Bishop of Anua for donating two pods to our Onsite Wastewater Demonstration Center in Springfield. Last October, he helped us update the technology we have at the center to educate both professionals and homeowners about options for onsite wastewater treatment. See the article on page 8-9 about this project.

Speaking of the Onsite Wastewater Demonstration Center, we are looking to host a Career Day during Septic Smart Week. Many of us know it is difficult to find good help these days. MSO is planning on an interactive day for high schoolers to experience different facets of the wastewater field. We are looking for volunteers to help with this event. The date is still being nailed down, but it will take place the week of September 18-22. Reach out to me if you would like to be involved.

Finally, classes are fewer in the summer since most of you are putting systems in the ground as the weather cooperates. If you still need some CEUs, we have a few classes planned and there are always online classes too.

Thank you for your continued support of MSO. I hope you all get to enjoy a little summer fun on the side of the busy work season. Stay safe out there!

Best regards,

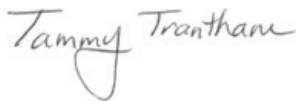

Tammy Trantham
Executive Director



There when you need us most

Count on us.



Pumps | Tanks & Basins | Pump Stations

Residential & Commercial Treatment

Controls | Drain Field Products

EZ-Pull

Monitor Unattended Pump Stations



NEW!

Remote monitoring and control of pump stations can be done through real time notifications and alarms to your computer or cell phone. You can monitor:

- high water levels
- power or pump failures
- other custom set thresholds

Minimize on-site visits and repairs! Call us about our IQ2 remote monitoring.

St. Louis 314-631-9200 **West Plains** Christina: 417-256-1255 **Lake of the Ozarks** Zach: 573-374-6444

Arkansas & SW MO Raymon: 479-640-0052

Our Current and Future Need

Over the past few years, rural Missouri has seen a large growth of residents. Many of these people have been looking for more space for their families, seeking land during the Covid crisis, or taking advantage of the distinct opportunities that rural Missouri provides to people. This has been coupled with an increase in rural tourism through Airbnb or VRBO style residencies and vacation homes. This means a large amount of development, not only the construction of new homes, but the renovations needed to bring older houses up to code before they will be put up for sale.

While this growth in population is great for the economies of local towns, it can cause greater stress on many of the natural resources that are so prized in Missouri. Some of the most vulnerable resources in Missouri are our numerous local streams and waterways. Over our history, mismanaged human waste is a major cause of pollution and damage to our smaller waterways. Luckily since 1996, Missouri has required permitting for new construction that includes regulations around the proper management of human waste. Since the implementation of these regulations, there has been a dramatic decrease in the levels of human waste that have been found in Missouri's waterways. One of the keys to maintaining these regulations and protection of the waterways is the work done by Missouri's Onsite Wastewater Soil Evaluators.



It is the job of these soil evaluators during the permitting process to assess what type of wastewater system will function best for each homeowner. At the current moment, there are only 43 registered soil evaluators for the entire state of Missouri, with many of them aging into retirement over the next few years. This begs the question as to who will be taking over this important role for the thousands of new residents of rural Missouri. As it currently stands, there are no formal in-person training programs, and few opportunities for continued growth after someone begins their career in this field.

Helping to provide quality paths for new soil evaluators into this career is important for ensuring not only the protection of our natural waterways, but also the value and beauty of the new homes that are being built. This is why Missouri Smallflows is interested in building not only an initial in-person training program, but also furthering the opportunities for continuing education courses over the next few years. These courses would ensure that there is a high level of professionalism across the state,

allowing homeowners to feel certain that the recommendations they are receiving will be relevant for their specific location.

The development of a training course for Onsite Soil Evaluators is of great importance not only for the Missouri Smallflows Organization, but for the well-being of the entire state. This course, taken prior to the certification exam, would allow for the development of a sound knowledge base for new Onsite Soil Evaluators and ensure the future professionalism of this trade. This course could then be expanded into continuing education courses for those who are already certified and offered multiple times a year to allow for the opportunity to examine and understand soils across the state. The long-term interests of many groups align in making sure that Missouri's Onsite Soil Evaluators have a strong initial training and long-term growth opportunities.

Please participate in our survey of soil professionals to help develop our training course: <https://forms.gle/TsSEQgA5A6x4B3ET8>

Written by: Joey Meinert, Graduate Assistant at University of Missouri



Wastewater Solutions

Treatment

Dispersal

Storage

Pumping

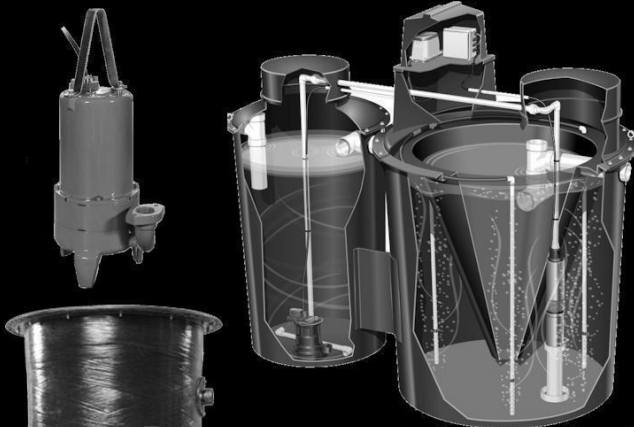

Pressure Sewer Systems

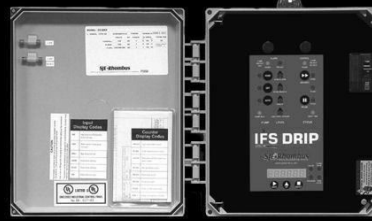

SJE RHOMBUS

Pump Controls



Effluent Pumps

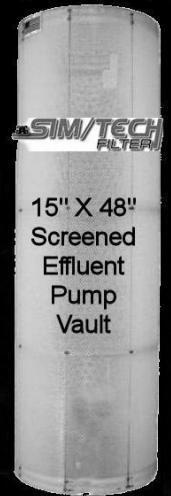

15" X 48" Screened Effluent Pump Vault



UV Disinfection



SJE Rhombus Solar Powered Alarm

Polylok D-Box

Polylok PL122 Effluent Filter



Salcor 3G UV



Drip Irrigation



STEP vaults



Snyder Septic Tanks Poly Nexgen D2



TG Rankin Co

233 Chesterfield Ind Blvd
Chesterfield, Mo 63005
636-532-4555
636-532-4716 fax

1801 Jasper St
N Kansas City, MO 64116
816-421-4646
fax 816-421-6120

www.tgrankin.com

Residential

Commercial

Municipal

INNOVATIVE PUMP SOLUTIONS

PHONE (417) 343-2211 FAX (417) 212-5346

ROGERSVILLE, MO

PROUDLY SERVING MISSOURI, ARKANSAS & ILLINOIS

PUMPS -- BASINS -- CONTROLS -- VFD'S
SWITCHES -- CONSTANT PRESSURE SYSTEMS
PHASE CONVERSION -- VOLTAGE DOUBLING

ORDERS IN BY 1:30 SHIP SAME DAY ON STOCKED ITEMS



Franklin Electric



Onsite Wastewater Training Center Donation

Generous Donation raises the bar at the Onsite Wastewater Training Center
 Author: Tammy Trantham, Executive Director of MSO

In October of 2022, MSO and Greene County were updating and refurbishing the Onsite Wastewater Training Center in Springfield. The area needed some work on fixing components and adding new demonstrations. One of those demonstrations was a Quanics pod that included foam cubes and BioCoir. We also had a separate Anua peat filter. These two technologies were showcasing potential treatment options that are used in Missouri.

The pods that were at the center were older models that were no longer in production. We reached out to Colin Bishop of Anua, and he generously donated two brand new pods.



The Puraflo peat fiber biofilter system uses a modular design with flexible options for expansion on the size of the system. It is compatible for seasonal or intermittent use and the P150N models are certified to NSF/ANSI Standard 40. This system was used in Greene County near Rogersville in a tough location. Due to the area constraints and water quality impact, this treatment method was engineered and used at this home. Information on that project can be found here: https://www.anuainternational.com/files/ugd/7a431b_7e4cff8cbac94122afe9fb24c9abe5d1.pdf

We also received a pod that had two technologies in it for educational purposes. The pod included the BioCoir and AeroCell Open Cell Foam Biofilter.

BioCoir utilizes coconut fiber (coir) to produce a high-quality effluent. It is certified to NSF/ANSI Standards 40 and 3rd party nitrogen reduction >50%. It utilizes spray nozzles to maximize effluent distribution over the coir media.

AeroCell Open Cell Foam Biofilter uses a synthetic media (foam cubes) to provide that increased surface area for high effluent treatment. The method is certified to NSF/ANSI Standards 40 and 3rd party nitrogen reduction >50%. There was a project based in Tennessee that used this technology to service a 70-lot residential development. The lots had shallow soils to bedrock and steep slopes. AeroCell cluster system was paired up with drip irrigation. You can read more about this project here: https://www.anuainternational.com/files/ugd/7a431b_63f5c59e79914f15a2e531887252cbff.pdf

We are very thankful to Colin Bishop for his generous donation to our training center. The center strives to have all different technologies to showcase to our professionals and homeowners. There are so many different types of treatment methods out there and each site has its own challenges. It's a great way to learn about the options you have to work with to find the right solution for your customer.

A big thank you to LaFollette Excavating for donating their time to install these units at the Training Center too. We appreciate your dedication to the industry!



If you are interested in donating to the training center, please reach out to MSO at contact@mosmallflows.org.

For more information on Anua: <https://www.anuainternational.com/>

2023 Septic Remediation

Announcing funding opportunities for low-income households to remediate onsite wastewater treatment systems!

2023 Septic Remediation Grant Program Funded by Greene County ARPA

Partners: James River Basin Partnership, H2Ozarks, Missouri Smallflows Organization and Greene County

Project Purpose: To focus on the identification and remediation of onsite wastewater treatment system (OWTS) failure in Greene County, Missouri and to protect public health, improve and protect water quality, and enhance economic development.

The James River Basin Partnership, H2Ozarks, The Watershed Committee of the Ozarks, and Missouri Smallflows Organization are pleased to offer a septic system remediation program to residents of the James and Sac River Watersheds. Funding comes from the Greene County American Rescue Plan Act (ARPA), with a goal of providing grant assistance for replacement systems (contingent on available grant funding).

There are more than 20,000 onsite wastewater treatment systems (septic systems) in Greene County. Failing or poorly functioning septic systems contribute to pollution of groundwater, streams, and springs.

If you are a Greene County resident living in the James or Sac River watersheds, and your septic system is failing, then you may be eligible to apply for one of our remediation grants. Please click on the button below for the application.

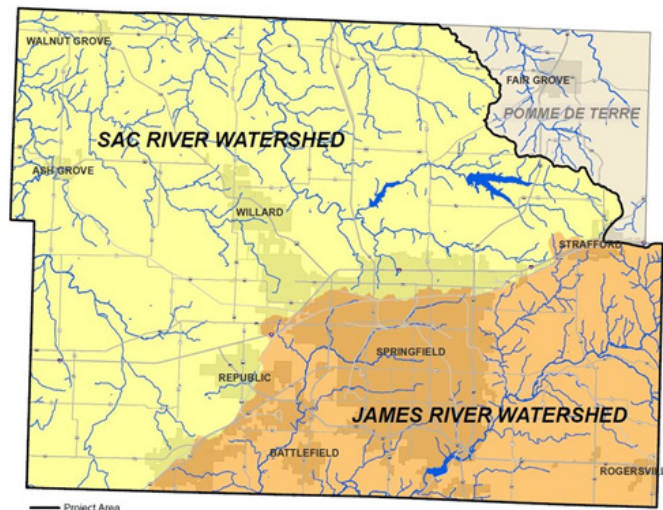

Please note that this program is limited to residential zoned property owners only. Consideration for grant award will be targeted to limited income households determined by two factors: (1) total family members in household, and (2) verifiable annual income.

Application Form is available here: <https://www.jamesriverbasin.com/greene-septic>

Professional Installers of Greene County! Please note the system repair or replacement will be paid directly to the installer by the grant partners administering the program. Contact JRBP or MSO for details on the process and with any questions about the program. Thank you for your support!

James River Basin Partnership, Phone: 417-836-4847

Missouri Smallflows Organization, Phone: 417-631-4027



GANEY

ENGINEERING

Protecting Today's Ground Water for Tomorrow

P.O. Box 308, Arnold, MO 63010

314-973-0377

ganeyengineering@yahoo.com

- septic system design
- sewer system design
- septic system evaluations
- onsite wastewater consulting
- Aeration Unit Supplier
- storm water consulting

Geoflow

Subsurface Drip



Wasteflow Dripline



BioDisc Filters



Flow Meters



Panels



Valves



Air Vents

800.828.3388

■ geoflow.com

MSO Member Event - September 9, 2023

***30 tickets available
for MSO members to purchase
and attend the game with our group!***



You must be an MSO Member; you may bring your spouse and family but one adult must be an MSO Member.

Tickets are \$30/person

Location: Red Bird Roost

Included: Ballpark Food (hot dogs, nachos, cookies, popcorn, boxed salads, coke products and water)

Contact Tammy at MSO to purchase tickets.
Email: contact@mosmallflows.org or phone: 417-631-4027



NOWRA Conference

NOWRA Conference – Hampton, Virginia

Join us for the national onsite wastewater conference event of the year. VOWRA is co-hosting the event with NOWRA in Hampton, Virginia. There will surely be a great line-up of speakers to listen to and visit with. The exhibit hall will be packed with companies to learn about new products. Field trips are being planned and a great social event to network with other professionals. Plan to attend!

Date: October 22-25, 2023

Where: Embassy Suites by Hilton Hampton Convention Center
Book your room today!

<https://www.nowra.org/conference/mega-conference/hotel-information/>



Onsite | **2023**
Hampton, Virginia
Wastewater
Mega-Conference



RENEW YOUR MSO MEMBERSHIP!

Call or email the MSO office to check your membership status



Membership only costs \$140 each year!

Thank you for supporting MSO!



STEWART Concrete Products

Proudly providing Missouri and the surrounding region with quality wastewater products



INFILTRATOR
water technologies

Lincoln, MO
(800) 743-0304
Webb City, MO
(888) 673-3321

norweco

*Engineering the future of water
and wastewater treatment*

Halfway, MO
(800) 798-0183

ZOELLER 
PUMP COMPANY

Spokane, MO
(877) 777-4302
Nevada, MO
(800) 743-0305

ORENCO ONSITE PRODUCTS

Built to work together. **Built** for the job. **Built** to last.



Lids, Risers & More

- Lids that don't warp or collapse
- Risers that don't deform
- Riser safety grates
- Riser/tank adapters
- Adhesives and dispensing guns
- All parts watertight
- Standard and custom sizes

Filters & Pump Vaults

- Filters that go longer between cleanings
- Pumps that last for decades
- Pump vaults for any kind of tanks
- Complete pumping systems



Controls

- Complete panel kits with floats
- Touch-safe controls
- Name-brand parts
- Resettable breakers
- Long-lasting contractors, millions of cycles
- UL, UL-C, CE listings; UL Type 4 rating



Missouri Water & Wastewater Products, Inc.
515 Old South 5, Camdenton, MO 65020
573-346-9991 • sales@mwwp.biz

Seth A. Coggin, P.E. • 417-291-5722
sethcoggin@mwwp.biz



814 Airway Ave., Sutherlin, OR 97479, USA
1-800-348-9843 • 1-541-459-4449 • www.orencosystems.com



Missouri Smallflows Organization

WHY SHOULD I BECOME A MEMBER OF THE MISSOURI SMALLFLOWS ORGANIZATION (MSO)?

MSO is a state-wide organization that brings together wastewater professionals to provide a network of information and education. Not only will you have the opportunity to take part in an annual conference and trade show, but you will get discounts on classes to keep up your state license.

As a MSO Member you can also become a member of the National Onsite Wastewater Recycling Association (NOWRA), our national affiliate. This national organization strives to bring top-notch educational opportunities to the state and takes part in lobbying at the national level for wastewater professionals.

MSO MEMBER BENEFITS

- Discounts on MSO classes throughout the state
- Discounted ticket for the Annual MSO Conference and Trade Show
- Quarterly newsletter sent via email or mail
- Tracking of MSO classes taken
- Opportunities to network statewide with other wastewater professionals
- Daryel Brock Memorial Scholarship opportunity for son or daughter

NOWRA MEMBER BENEFITS

- Discounts on National NOWRA Conference
- Listing on Septic Locator on NOWRA website
- Wells Fargo 0.25% financing discount for equipment over \$50,000
- Can order magnetic signs for business
- Lobbying at the national level
- Receive bi-annual NOWRA magazine

WWW.MOSMALLFLOWS.ORG

WWW.NOWRA.ORG



REGISTRATION FORM

YES! SIGN ME UP FOR MEMBERSHIP WITH MSO!

Individual MSO Membership for \$140

Interested in a Company Membership for multiple employees? Call our office.

Name: _____

Company: _____

Mailing Address: _____

City: _____ State: _____ ZIP: _____ County: _____

Email address: _____

Phone Number: _____ Cell Number: _____

Sign me up for email updates on classes

I would prefer the quarterly newsletter by: Email Mail

DHSS License Numbers:

Basic Installer: _____ Advanced Installer: _____ Inspector: _____

Onsite Soil Evaluator: _____ Percolation Tester: _____

NEW! Pay online!
Visit www.mosmallflows.org

Or Send Form and Payment to:

Missouri Smallflows Organization
2733 E Battlefield #132
Springfield, MO 65804
Phone: (417) 631-4027

Email: contact@mosmallflows.org

Check here if billing address same as mailing address above

Card #: _____

Exp: ____/____ CVV: _____

Name on Card: _____

Card Billing Address: _____

State: _____ Card Billing Zip Code: _____

LISTING OF MSO CLASSES

PLEASE REGISTER AT LEAST TWO WEEKS PRIOR TO THE CLASS!

Call our office to register at 417-631-4027

Or find the Registration Form on our website: www.mosmallflows.org

Earthen Structures

Location: Springfield, SI Precast

Date: June 20, 2023

Half day class: 8:30 AM - 1:30 PM

DHSS General CEUs: 4.25

Select: Basic: 3.5, Advanced: 3.75, Inspector: 3.25, OSE: 3.25,

Perc Tester: 3.25

*Note: This location has 2 flights of stairs to the meeting room. There is no elevator available.

Onsite Pumps Panels & Electrical

Location: Springfield, SI Precast

Date: June 21, 2023

Half day class: 8:30 AM - 1:30 PM

DHSS General CEUs: 4

Select: Basic: 3.5, Advanced: 3.5, Inspector: 3.5, OSE: 0,

Perc Tester: 0

*Note: This location has 2 flights of stairs to the meeting room. There is no elevator available.

Aerated Treatment Units

Location: Kearney, Kearney Winsupply

Date: July 12, 2023

Full day class: 8:30 AM - 4:00 PM

DHSS General CEU: 6

Select: Basic: 3.5, Advanced: 6, Inspectors: 3.5, OSE: 1.0,

Perc Testers: 1.0

Earthen Structures

Location: Kearney, Kearney Winsupply

Date: July 13, 2023

Half day class: 8:30 AM - 1:30 PM

*CEUs pending re-approval

DHSS General CEU: 4

Select: Basic: 3.50, Advanced: 3., Inspectors: 3, OSE: 3.25,

Perc Testers: 3.25

Inspecting Tanks, Lagoons & LPP

Location: Troy, Lincoln County Health Department

Date: August 24, 2023

Full day class: 8:30 AM - 3:00 PM

DHSS General CEUs: 5

Select: Basic: 0, Advanced: 0, Inspector: 5, OSE: 0,

Perc Tester: 0

Trickling through Media Filers

Location: Troy, Lincoln County Health Department

Date: August 25, 2023

Full day class: 8:30 AM - 4:00 PM

DHSS General CEUs: 6

Select: Basic: 0, Advanced: 6, Inspector: 4, OSE: 0,

Perc Tester: 0

Drain Fields & Water Management

Location: Camdenton, Mid-County Fire Department

Date: September 28, 2023

Full day class: 8:30 AM - 4:00 PM

General CEUs: 6.0

Basic Installers: 4.5, Advanced Installers: 6, Inspectors and Evaluators: 3.5,

Onsite Soil Evaluators: 6, and Percolation Testers: 4.5

Troubleshooting Onsite Systems

Location: Camdenton, Mid-County Fire Department

Date: September 29, 2023

Full day class: 8:30 AM - 4:00 PM

General CEUs = 6

Basic Installers: 6, Advanced Installers: 6, Inspectors: 6, OSE: 0, and

Percolation Testers: 0

Inspecting Tanks, Lagoons & LPP

Location: Imperial, Ganey Engineering

Date: October 17, 2023

Full day class: 8:30 AM - 4:00 PM

DHSS General CEUs: 5.0

Select CEUs: Basic: 0, Advanced: 0, Inspector: 5, OSE: 0, Perc Tester: 0

Trickling through Media Filters

Location: Imperial, Ganey Engineering

Date: October 18, 2023

Full day class: 8:30 AM - 4:00 PM

CEUs: General CEUs: 6

Select: Basic: 0, Advanced: 6.0, Inspectors: 4.0, Onsite Soil Evaluators: 0,

Percolation Testers: 0

Aerated Treatment Units

Location: Jefferson City, Cole County Health Department

Date: November 9, 2023

Full day class: 8:30 AM - 4:00 PM

General CEUs: 6

Basic Installers: 3.5, Advanced Installers: 6, Inspectors and Evaluators: 3.5,

Onsite Soil Evaluators: 1.0, and Percolation Testers: 1.0

Drip Irrigation

Location: Jefferson City, Cole County Health Department

Date: November 10, 2023

Full day class: 8:30 AM - 4:00 PM

General CEUs = 6

Basic Installers: 3.5, Advanced Installers: 6, Inspectors and Evaluators: 6,

OSE: 3.5, and Percolation Testers: 0

More classes are being scheduled.

See our online classes available on our website: www.mosmallflows.org

Seminar refund policy available online

Daryel Brock Memorial Scholarship Recipient

Madison Sieg awarded the Scholarships for 2023



This year we had two scholarships available for members' children to apply. The annual Daryel Brock Memorial Scholarship is awarded each year. During this scholarship application period, the MSO Board decided to host another scholarship in honor of Ken Kramer for 2023. In essence we had two scholarships available during 2023.

We had one applicant for the scholarship, Madison Sieg. She is the granddaughter of David Casaletto, Kimberling City, Missouri. Madison was an outstanding candidate for the scholarship program. She exceeded all expectations on the application requirements. The Board of Directors decided to award her both scholarships for the year. Madison was the recipient of a total scholarship amount of \$1,250.

Madison plans to attend Missouri State University in the fall. Best of luck in your studies, Madison.

For more information about the scholarship program, see our website:
<http://www.mosmallflows.org/daryel-brock-memorial-scholarship.html>

Applications are due annually for this program on February 15. If you have a senior in high school during the school year of 2023 – 2024, they will be eligible to apply by February 15, 2024.

We have something new to show the Show-Me State!

See us at this year's MEGA-Conference, co-hosted by MSO & NOWRA!
October 30 thru November 2 in Springfield, MO.
(If you can't wait, call today!)



- Simple Installs
- Simple Treatment & Disposal • Simple maintenance • Flexible design options
- Perfect for small and complicated sites as well as commercial operations

Ask us about
Training Seminars
in your area!



Innovative Onsite Products and Solutions Since 1970

800-444-2359

www.eljen.com





**Manufacturers of
 STEPS-SEPTIC TANKS
 PARKING CURBS-SPLASH BLOCKS-GREASE INTERCEPTORS
 AIR CONDITIONER BASES-PRECAST CONSTRUCTION ITEMS
 CONCRETE FENCE**



Does your customer have a grinder pump problem?

Need a partner for servicing or replacing grinder pumps when your customer calls? Call Flo-Systems to help you out. Let us Help You service your customers.

If you need a helping hand when a customer calls about their grinder pump, let us go make the service call for you. We can be an extension of your service crew. Let Flo-Systems provide your client with with an Upgrade from E/One, We can perform the work, and do the billing for you. Call to discuss the details

Contact your local sales representative:
 Flo-Systems Process Equipment, Inc.
 905 Cherry Ln • Troy, IL 62294
 618-667-7890 • www.flosystems.com
 Dan Hufker 618-979-0884





Online Courses available for CEUs in Missouri!

Continue your education from the comfort of your office or home!

In partnership with NOWRA, Missouri Smallflows Organization has online courses available for onsite wastewater professionals to earn more CEUs for their license renewal. You can read all about these courses on our website with CEU summaries.

<http://www.mosmallflows.org/online-classes.html>

As a member of MSO, you save \$15/credit hour for online classes!

Be sure your membership is up-to-date! Contact our office!

Phone: 417-631-4027 or email: contact@mosmallflows.org

NOWRA Installer Academy Module	8 different classes available Select classes that you are interested in!
NOWRA Troubleshooting Module	9 different classes available Select classes that you are interested in!
NOWRA A to Z Module	3 different classes that you can bundle for an 8 hour course OR Select the classes you are interested in!
NOWRA Onsite Mega 2020	6 different classes from the 2020 NOWRA Virtual Conference. Only available for a limited time!

To see complete course listings go to the MSO website.

<http://www.mosmallflows.org/online-classes.html>

MSO office phone: 417-631-4027



Flagg-Air® 340HT Series

The Flagg-Air® shaft-style septic aerators are compatible replacements for OEM aerators in Jet® and Norweco Singlair®* septic systems. Powder-coated steel brackets fit either the 10-inch Jet® or the 12-inch Norweco Singlair® tank openings.

- Proven performance in OEM tanks
- High-torque, continuous duty motor
- Made in the USA
- 2-Year limited warranty
- Trusted by professionals for over 30 years!

ORDER TODAY!



on orders over \$30

Special contractor pricing available!

(800) 778-1540 | www.septicTankParts.com
7059 Highway 47 Union, MO 63084

Flagg-Air® 340HT-J Flagg-Air® 340HT-N



FA 340HT-N
Alternative for all
Norweco® models

FA 340HT-J
Alternative for all
Jet® models



*Norweco Singlair® is a registered trademark of Norwalk Wastewater Equipment Company, Inc. Jet® is a registered trademark of Jet, Inc. All original manufacturer's names, drawings and part numbers are used for identification purposes only and we are in no way implying that any of our products are original equipment parts, or are affiliated with, or endorsed or approved by the original manufacturers.

Visit SepticTankParts.com for our entire line of septic pumps, aerators, rebuild kits, and more!



WHIRLWIND™
Linear Air Pumps



WHIRLWIND™
Regenerative Blowers



MAX FILTER SOCKS
(30-PK)



MAXAIR500™
Submersible Aerator



Residential

Sewage Treatment Company

12800 2nd Street

PO Box 248

Grandview, MO 64030-0248

Phone: 816-966-8885

Fax: 816-966-8778

Email: info@residentialsewage.com

Website: www.residentialsewage.com



We specialize in sales, design, and service of alternative onsite wastewater products.

Distributing quality products from these manufacturers and more!

Norweco, Inc.

Allied Concrete Products

Infiltrator Water Technologies

Liberty Pumps

Geoflow, Inc.

SJE Rhombus

GAG Sim-Tech

K-Rain

Call our office today for a quote!

816-966-8885

Like us on Facebook! 

Your alternative wastewater specialist!



MODEL 952

- UL listed as a NEMA 6p enclosure (watertight submergence test)
- Install directly in ground or in pump tank on effluent line
- Complete disinfection without the use of chemicals
- Hermetically sealed electrical components
- High capacity disinfective reservoir
- Kapton seals improve serviceability
- Rated treatment of 10 gallons/min

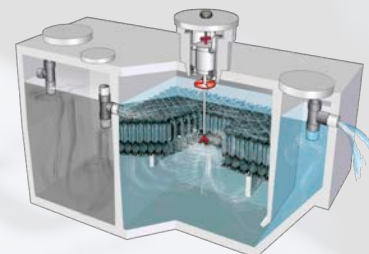
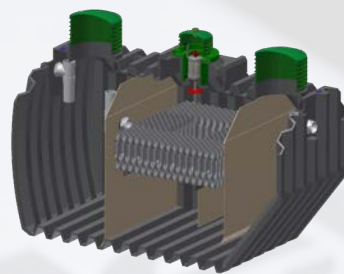

RESIDENTIAL & COMMERCIAL TREATMENT PLANTS

- Concrete and rugged polyethylene material
- 500-1500 GPD Residential Systems
- 1500-300,000 GPD Commercial Systems
- Up to 800 GPD in plastic design
- A single moving part
- Innovative design for easy system servicing
- No filters to clog
- Lifetime exchange program

ACCU-TAB WASTEWATER TABLETS

- U.S. made, recognized global brand with no imported ingredients
- Chlorine tablet with beveled edges to minimize wicking
- Consistent chlorine strength for reliable dosing control
- No measuring, mixing, or spilling of chemicals common with granular and liquid chlorine
- Stearate free formula with balanced pH



www.jetincorp.com
440.461.2000



Wastewater Treatment Solutions
Founded on Innovation. Anchored by Service.®



Recognized as the Leader
in Precast Concrete Tanks
& Specialty Products

Over
50+ Years
EXPERIENCE



**Residential & Commercial
Waste Water Treatment Specialist**

Design, Build & Implement
12,000 GPD to 96,000 GPD

Tony@precasttanks.com | 314-267-5375



Aerobic Septic Systems
Class 1 Aeration 500 GPD to 1000 GPD
www.precasttanks.com



HOOT SYSTEMS, LLC.
www.hootsystems.com

Call toll-free
888.878.HOOT

LA- Hoot

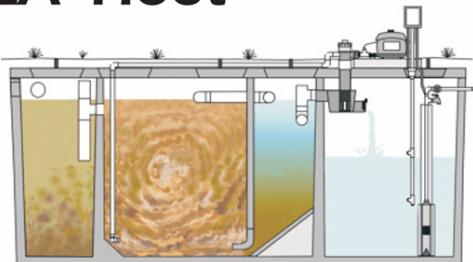

Hoot Systems Local Dealer

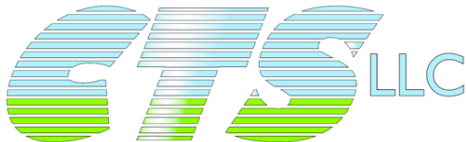

314-267-5375

Hoot Systems Offers:

- 4 Models of NSF Standard 40 Systems
- 2 Models of NSF Standard 245 Systems
- Integrated Drip Packages
- Commercial & HS Treatment Systems for C-Stores, Restaurants, RV Parks, Schools, Churches and Shopping Centers

Please contact your Local Dealer -
Tony Champion or the Hoot Corporate
Office for more details!



Missouri
Smallflows
Organization

DRUG-FREE WORKPLACES

SEE MORE INFORMATION AT WWW.MEM-INS.COM

Never report to work impaired by illicit drugs, illegally used prescription medications, or alcohol. Work is more dangerous when employees are impaired by both legal substances AND illicit drugs. Never report for work impaired by illicit drugs, legal medications, illegally used prescription medication, recreational substances, or alcohol. Employers are encouraged to be drug-free workplaces - meaning employers would perform new hire, post-incident, random and reasonable suspicion screens.

- Impaired employees put themselves, coworkers, and motorists at risk. Employees that work impaired by alcohol or illicit drugs are more likely to have workplace injuries and incidents.
- Injuries sustained by impaired employees cost the company twice as much as those without impairment.
- Theft, assaults, harassment, absenteeism, and poor quality are additional problems associated with drug use at work.
- A hangover may mean you are still impaired. You could also be dehydrated and fatigued as well.
- Because of this, employers are encouraged to implement a drug-free workplace that includes language on impairment, recreational substances, illegally used prescription medications, illicit drugs, and alcohol use.
- Please speak with management if you're using any medication that could impair your ability to work safely.
- Company drug tests can screen for the following:
 1. Cannabis (Marijuana)
 2. Cocaine
 3. Amphetamines (Methamphetamine)
 4. Opioids (Heroin, morphine)
 5. Barbiturates
 6. Benzodiazepines
 7. Phencyclidine (PCP)
 8. Methaqualone
 9. Methadone
 10. Propoxyphene
- A breathalyzer is used for an alcohol screen.
- Do not report to work if you're impaired by or under the influence of, or have used alcohol, are impaired, or if you have drug metabolites in your system.
- Do not perform safety-sensitive jobs when you've been prescribed a medication with warnings that prohibit driving or using equipment. You could be impaired using your prescription medication.
- If you suspect that a coworker is using illicit drugs or drinking alcohol on the job – or if they're impaired - report it to management immediately.



IMPAIRMENT BY DRUGS, ALCOHOL AND MEDICATIONS AFFECTS YOUR SAFETY AT WORK. DO NOT WORK WHILE IMPAIRED.



ACCORDING TO MISSOURI STATE HIGHWAY PATROL CRASH STATISTICS, IMPAIRED DRIVING CONTRIBUTES TO 40% OF FATALITY CRASHES IN OUR STATE.



RESPONDERS ARE STANDING BY WHEN ALCOHOL OR ILLEGAL DRUG USE GETS YOU SERIOUSLY INJURED. JUST DIAL 911 FOR AMPUTATIONS, CRASHES AND SEVERE BLEEDING.

MeM MISSOURI
EMPLOYERS
MUTUAL

These advisory materials have been developed from national standards and sources believed to be reliable, however, no guarantee is made as to the sufficiency of the information contained in the material and Missouri Smallflows Organization assumes no liability for its use. Advice about specific situations should be obtained from a safety professional. 05-12-2023 by MW



INFILTRATOR
water technologies

Engineered For Performance



ADVANCED **ENVIRO**SEPTIC™

Passive Onsite Wastewater Treatment Systems

Combined Treatment and Dispersal

- Treats and disperses wastewater in the same footprint
- Flexible configurations for sloped or curved sites
- Testing in accordance with NSF/ANSI 40 for treating domestic strength wastewater to Class I levels
- No electricity, replacement media or additional maintenance required



Residential Advanced Wastewater Treatment Systems

Innovative approach to onsite wastewater disposal where nitrogen reduction is required.

- Nitrogen reduction greater than 50%
- The fixed film process suitable for continuous or intermittent use
- Industry proven solution with both NSF/ANSI 40 and 245 certifications
- Easy to maintain – no mechanical parts



Certified to
NSF/ANSI Standards 40 & 245



CALL FOR INFORMATION AND A DISTRIBUTOR NEAR YOU!

Curtis Cluckey • (816)769-0087 • ccluckey@infiltratorwater.com
Rick Kirkpatrick • (860) 575-8020 • rkirkpatrick@infiltratorwater.com



**Missouri
Smallflows
Organization**

2733 E Battlefield #132
Springfield, MO 65804

PRSR STD
US POSTAGE
PAID
SPRINGFIELD,
MO
PERMIT #777



YOUR TOTAL WASTEWATER SOLUTION
888-262-7383

Residential

Septic tanks
Aerobic Treatment
Drip Irrigation Packages
Pumps and Controls
Lids & Risers
Infiltrator Chambers



Commercial

Treatment up to 100,000 gpd
Custom Cast STEP Projects
Sand Filter Components
Grease Interceptors
Commercial Size Castings
Call Sean @ 573-280-4130

Grandview, MO	St James, MO	Springfield, MO	Mtn Grove, MO	Jackson , MO	Versailles, MO	Moberly, MO	St Joe, MO
816-966-9000 11919 Cartwright	573-265-7028 14241 Old Hwy 66	417-883-2355 1501 S Empire Ave	417-962-3126 11433 Dunn Dr	573-243-6052 3520 Matthew St	573-378-5474 900 Petty Dr	660-263-1213 1501 Rt DD	816-233-0248 12824 CR 352